

Lifecycle Simulation

Siemens PLM Software

www.siemens.com/plm

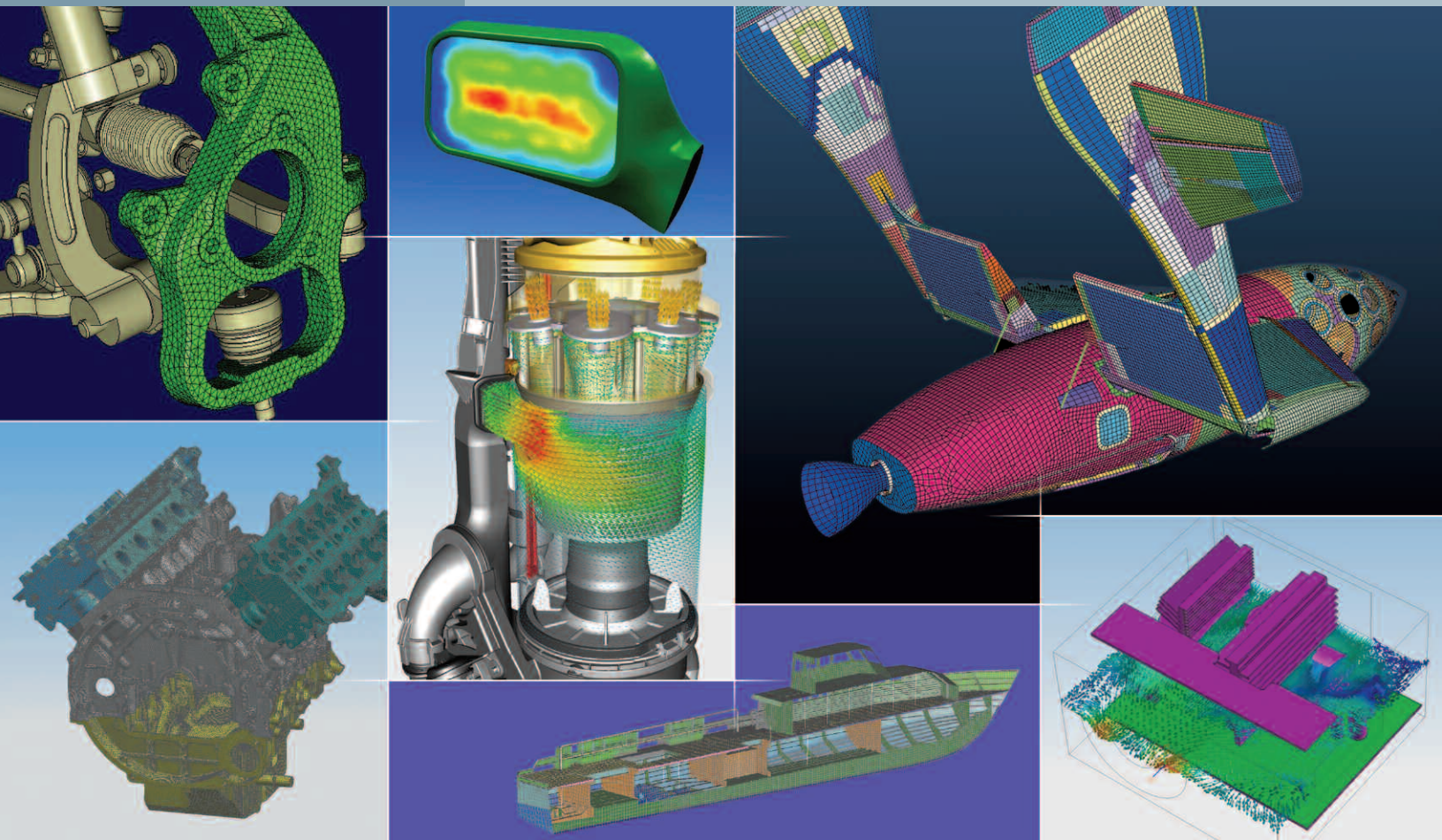

Design in quality and drive product innovation by making simulation pervasive throughout the product lifecycle.

NX

SIEMENS

Why lifecycle simulation?

Industry pressure to reduce costs and improve quality is driving growth in the use of digital simulation throughout the product lifecycle.

Choosing the right tools is key to achieving the business benefits of Lifecycle Simulation. Companies need to consider technology, scalability, integration and management.

- The right technology ensures that simulation can accurately represent the physical environment
- Scalable solutions adjust to a broad range of users' skill levels and a growing scope of requirements
- Integration with other simulation tools and with product development applications is important to both the efficiency and effectiveness of the CAE solution
- Management of processes and data is critical for automation and continuous improvement of critical simulation workflows

Why Siemens PLM Software

NX™ software helps manufacturers develop products right the first time with a complete range of simulation, validation and optimization tools. At every stage of development, these integrated tools check products and processes to ensure quality, performance and manufacturability.

Product quality with fewer prototypes

With NX, companies accurately model and analyze product performance characteristics while minimizing physical prototypes.

NX simulation applications include dynamic motion simulation, basic strength analysis, system-level performance evaluation and advanced response, durability, fluid flow and multi-physics engineering analysis for robust simulation of functional performance.

NX and Teamcenter® software manage CAE processes, workflows and data to deliver vital performance feedback where it is needed to improve your products.

Your business benefits

- ▶ Faster to market with innovative new products
- ▶ Lower risks by understanding performance
- ▶ Lower costs from:
 - physical prototyping
 - engineering change orders
 - in-service warranty
- ▶ Increased product quality

Lifecycle Simulation

Lifecycle Simulation enables continuous performance simulation introduced early in the development process. It allows more design options to be reviewed and, therefore, better decisions to be made.

Lifecycle Simulation features the PLM industry's first end-to-end integrated simulation solution for the enterprise. The vision enables Siemens' largest customers, as well as the smallest, to collaborate using open simulation technology. By addressing the growing need to deliver and manage simulation across the entire product enterprise, Lifecycle Simulation will help validate ideas faster and accelerate the innovation process.

The four keys to Lifecycle Simulation are:

Real-time represents Siemens' ability to solve the world's largest problems and get results in time to guide design decisions. Success requires "raw power"; Siemens' multi-physics solvers are led by NX Nastran which has defined the industry performance benchmark. While most of Siemens' customers will never need to solve the world's largest problems, all customers benefit from results that come in time to drive their design.

Visual talks to productivity, critical when considering that most specialists spend the bulk of their time developing mathematical models instead of leveraging the results that they generate. By integrating NX with Teamcenter® workflow software to create unique drag-and-drop process tools, Siemens enables engineers to embed their applications and process knowledge into design. Reducing the time to manipulate both design and analysis geometry and create models is a core competence. Automated geometry abstraction, used to "repair" design geometry, is an example of one of the ways Siemens is reducing the time to build models from weeks to hours.

Managed is about the capture and re-use of knowledge on team and departmental levels. As products become more complex, engineers are challenged to handle increasing varieties of product data, optimizing highly complex systems that can include mechanical, electrical and software components. The Lifecycle Simulation strategy is integrated with the world's best and most popular data management solution. Siemens will be announcing some new and exciting capabilities in this area.

Finally, history and complexity demonstrate that no company can or will satisfy all simulation needs. Partnerships across the competitive divide are key to customer success and the Lifecycle Simulation strategy has extended Siemens' **open framework** to enable customers to cost effectively leverage and maintain their investments in proprietary and 3rd party technology.

When it comes time to spread the benefits of simulation, it is important to recognize that not all consumers of simulation data wish to either learn how to use specialist tools or pay the cost of specialist applications. Here Siemens is leveraging JT™, a freely available published standard, to enable managers and engineers to communicate and efficiently share their insight to new areas of the product development process.

> Real-time,
visual,
managed,
open

Benefits extend right across the balance sheet and include lower downstream costs and risks, fewer physical prototypes, changes to tooling, reduced material costs, warranty costs, engineering changes and less rework.

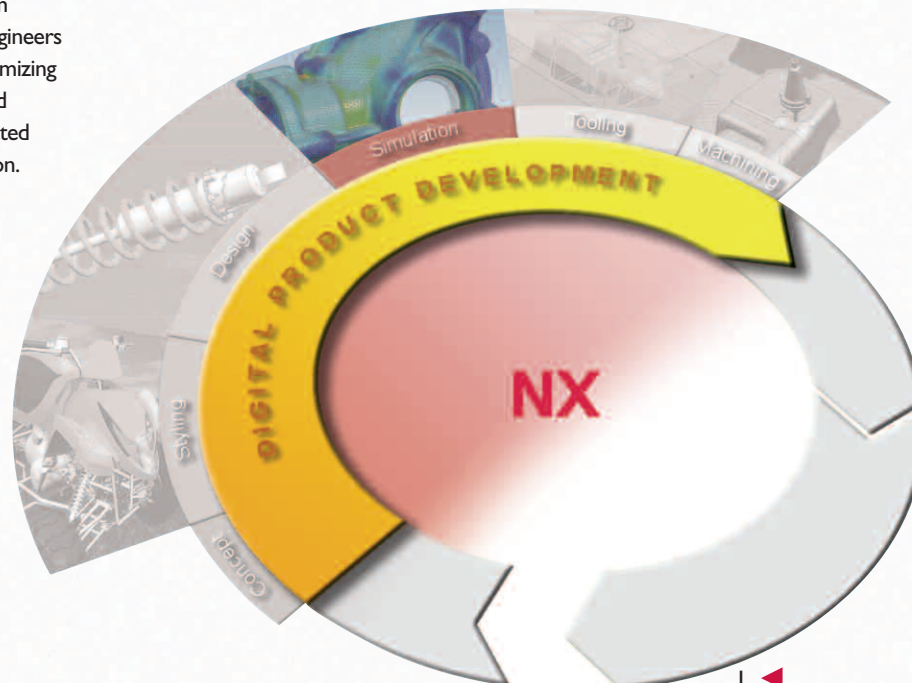

A key to business success

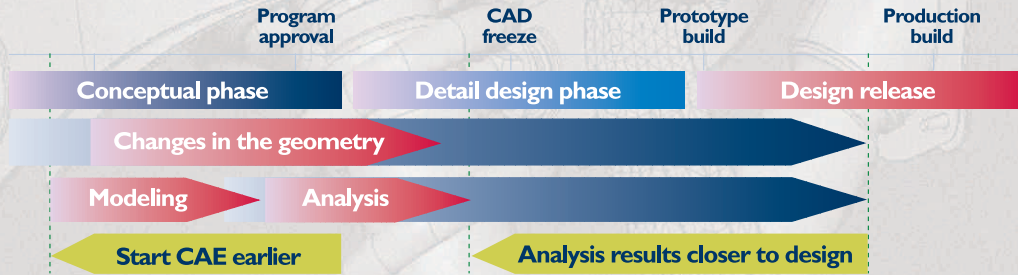

Ensuring simulations are performed with up-to-date design geometry even with multiple revisions helps ensure that the predicted performance characteristics more accurately reflect the final “as-delivered” product.

Manufacturers rely on product development to deliver products that add value to their portfolios. Efficient designs reduce material and manufacturing labor costs. Designs that have been studied and improved have lower warranty costs and fewer liability issues. By increasing the effective use of engineering simulation, project managers can reduce many downstream costs and risks.

Improving the process through simulation

Lifecycle Simulation enables improvements throughout the development process, allowing exploration of more concepts while reducing direct costs associated with expensive physical prototypes. Simulation enables faster, more informed decisions that lead to better products. Better products have better performance and higher margins, which directly benefit the bottom line. Integrated within enterprise data management systems, Lifecycle Simulation enables management to leverage knowledge of product performance to reduce development cycle time.

By getting to market faster, companies gain significant financial and market share increases, but the benefits reach beyond the balance sheet. Increased confidence that designs will work enables suppliers to reduce contingencies in contract negotiations, while efficient process tools and scalable environments release scarce resources to focus on new business opportunities with new revenue possibilities.

- ▶ Front-loaded simulation supports better decisions earlier in the process
- ▶ Faster computation technologies mean a faster response
- ▶ Accurate results give you confidence in your design
- ▶ Scalable tools help drive collaboration among designers, engineers and analysts
 - Easy to use with solutions that are easy to understand
 - Complete in scope to support even the most demanding analyst

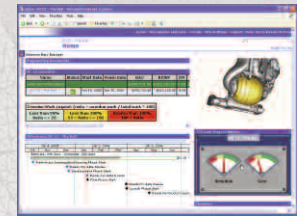
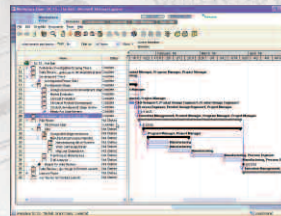

Reducing waste, improving quality

Automation and infrastructure enhancements bring immediate value to engineers, analysts and teams tasked with developing the infrastructure to increase the use of simulation. Simulation, validation and optimization capabilities are pervasive attributes of NX. NX directly supports core business initiatives like Lean Design and Design for Six Sigma, helping reduce waste caused by defects with associated warranty and support costs, improving performance and manufacturability and reducing the lengthy and costly design-build-test cycles of physical prototypes.

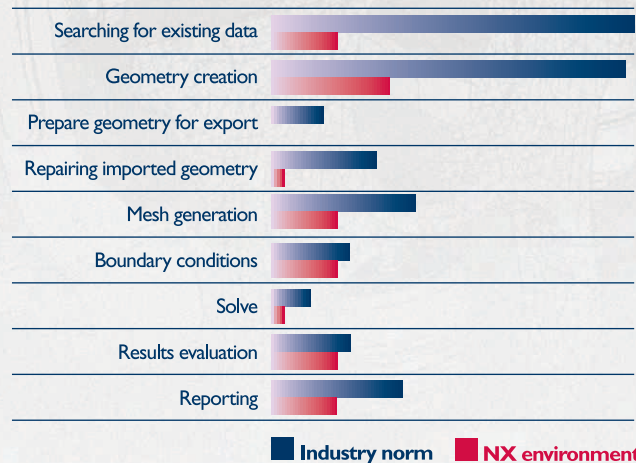

With advanced technologies, NX significantly reduces the overall cycle time required for typical simulation tasks.

From requirements to retirement

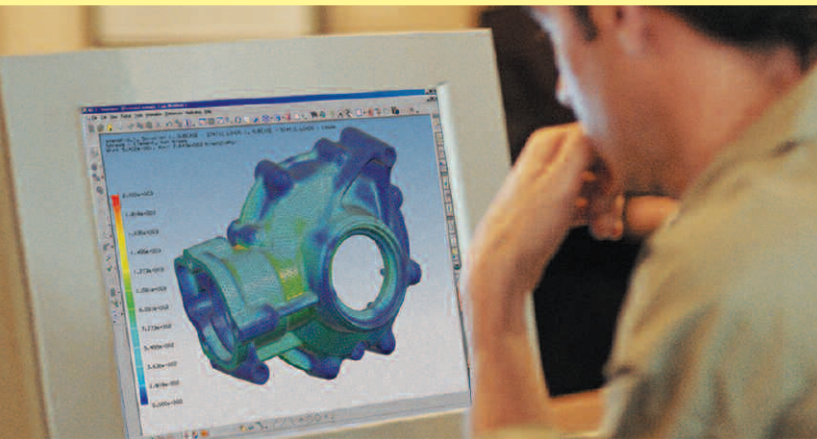

By increasing the effective use of engineering simulation, program managers can reduce many downstream costs and risks. Lifecycle Simulation enables improvements throughout the R&D process, allowing more innovative concepts to be reviewed while reducing direct costs associated with expensive physical prototypes.

The value of an efficient design is well understood in terms of reduced material and manufacturing labor costs. Simulation enables faster, more informed decisions leading to better products. Better products have better performance and higher margins, which directly benefits the bottom line.

Effective simulation gives companies a competitive edge, enables immediate feedback during the design process and gives project teams better information to make better decisions. Siemens is uniquely qualified to deliver simulation technology that adds value to the entire development environment. The unique combination of strengths in Teamcenter and NX provides tools, data and process support for all areas of the product lifecycle.

Benefits of simulation in the NX environment:

NX covers the breadth and depth of digital prototyping requirements across a wide range of industry applications and user technical backgrounds. Applications include process-centric tools tailored for use by design engineers, and “multi-CAD” analysis environments for the most demanding specialists using industry-standard solvers, including NX Nastran.

- ▶ **New product development** – Leverage front-loaded applications that support better decisions earlier in the process
- ▶ **Value chain synchronization** – Exchange innovative ideas and synchronize requirements across your global supply chain
- ▶ **Enterprise data management** – Reap the benefits of knowing that your extended enterprise is working on the same page across your portfolio’s lifecycle
- ▶ **Commonization and re-use** – Use common tools to drive design and engineering efficiency by leveraging easy-to-use solutions that support even the most demanding analysis
- ▶ **Knowledge/intellectual property management** – Increase the flow of information into process development to ensure success and capture new insights for future development
- ▶ **Compliance** – Manage requirements and industry standard applications to achieve compliance and mitigate risks
- ▶ **Production efficiency** – Leverage a pervasive simulation environment integrated with product design, process design and product information
- ▶ **System engineering and mechatronics** – Use systems views and validate electromechanical processes for the most efficient production operation possible

PROVEN RESULTS

- ▶ *“Real-time simulation not only requires raw computational power, it also involves the need to capture and re-use the expertise of advanced analysts. The result is a knowledge-enabled environment that facilitates earlier and better design decisions.”*

*Ken Versprille
Collaborative Product Development Associates, LLC*

Real-time – in-time to impact design

The ability to solve the world's largest problems and get results in time to guide design decisions is important. "Real-time" simulation requires raw engine power, and NX Nastran is demonstrating a unique ability to solve the largest and most challenging problems. Numerical performance is a product of Siemens' commitment to deliver the fastest and most robust solver in the industry. Not just for dynamics problems, NX Nastran is a core part of an integrated multi-physics portfolio and a key element of Siemens' Lifecycle Simulation vision.

NX Nastran is widely deployed across many industries to provide comprehensive product performance simulation in a broad range of engineering disciplines, including stress, displacement, buckling, failure, vibration, shock, heat transfer; acoustics and aeroelasticity. It is complemented by an extensible family of advanced analysis technology; available to address multi-body mechanisms simulation, advanced thermal and radiation analysis, combined flow/thermal analysis for electromechanical systems, dynamic response analysis and advanced durability analysis.

NX Nastran SDK, a software development kit, provides users access to development tools and utilities designed to simplify the task of leveraging the strengths of NX Nastran to add value to customer and industry-specific tools.

Nastran has been recognized for over 30 years as the analysis solution of choice in major manufacturing industries. In 2003, Siemens acquired the MSC.Nastran source code, development environment and rights to develop and market Nastran as settlement of an FTC action to maintain competition in the market.

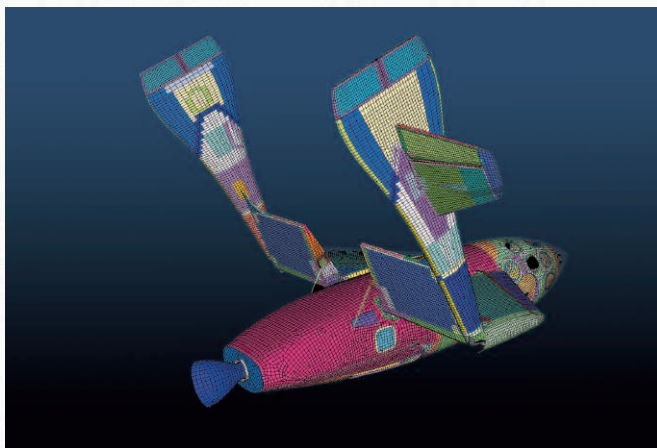
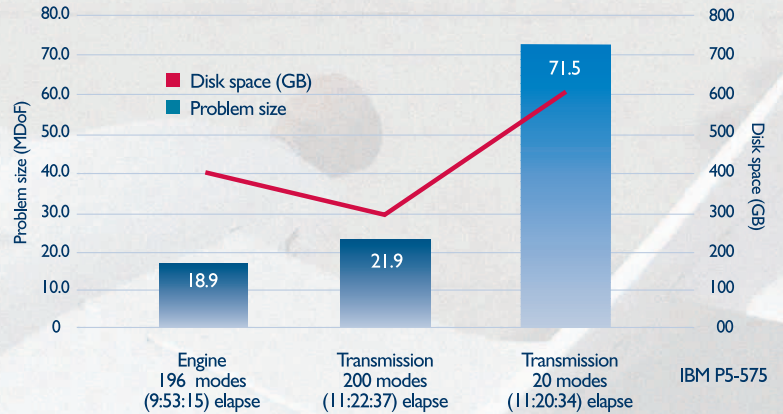
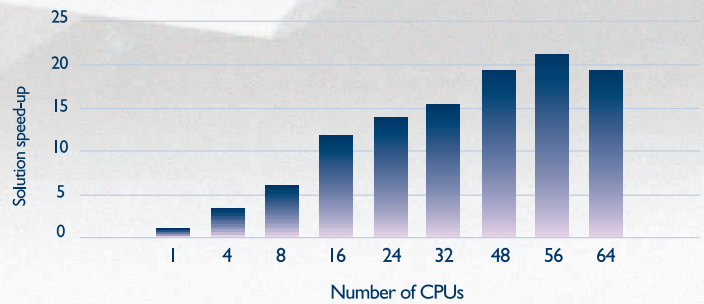

Image courtesy of Scaled Composites, LLC and Quartus Engineering, Inc.

NX Nastran – large model performance



Solving the largest numerical challenges is critical to the ability of engineering analysts to positively impact design decisions and a key focus for Siemens development and research.



Trimmed car body – 2.3 million degrees of freedom, 380,000 node points, 900 mode shapes
IBM P650 workstation cluster 64 POWER4 (1.5 GHz) CPUs

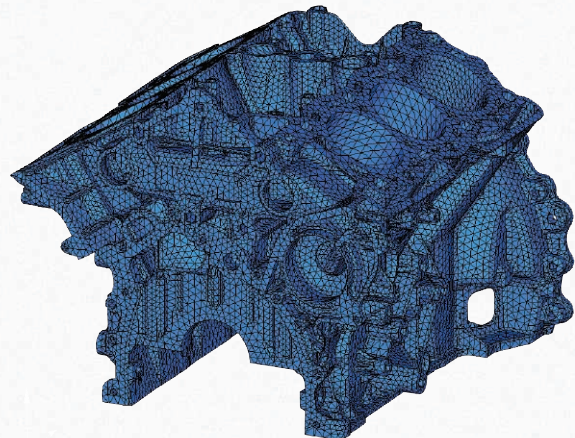

Visual-driving productivity

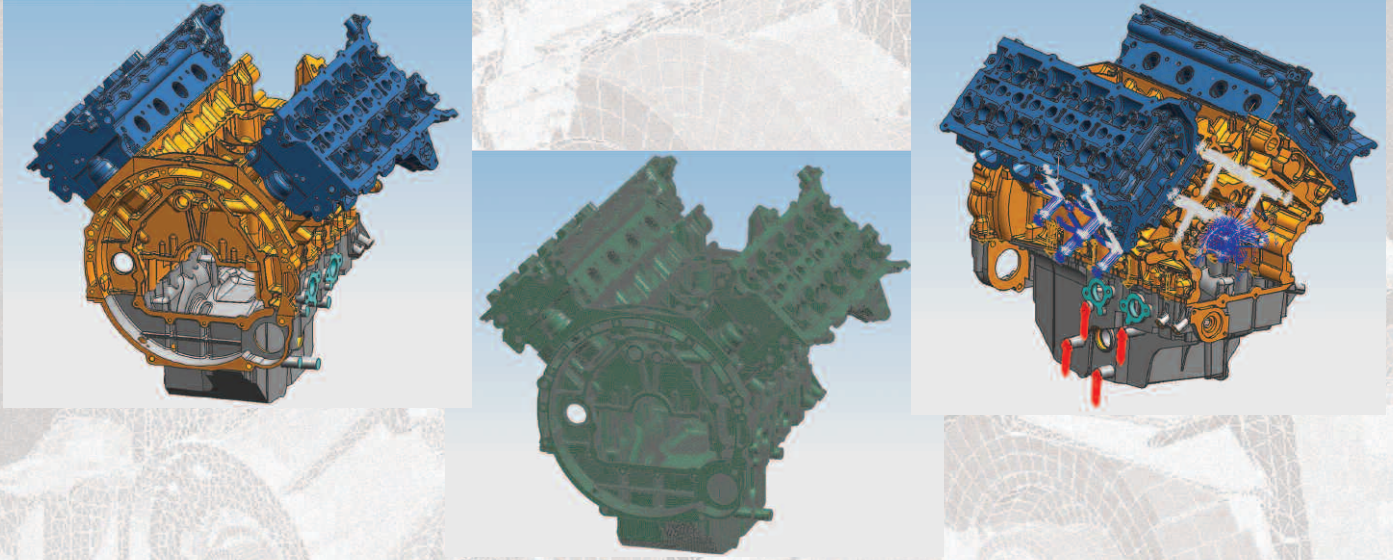

NX provides comprehensive capabilities and world-class technology for building finite element models and understanding finite element results, including the ability to create and modify 3D geometry and surfaces for the purposes of geometry abstraction and finite element modeling. This advanced application can accept input from a wide variety of geometry creation sources including Pro/Engineer, Catia, SolidWorks, Solid Edge® software and AutoCAD, as well as industry standard data exchange formats such as IGES, STEP, VDA, JAMA-IS, STL and JT. NX also has direct solver interfaces available for MSC.Nastran, Abaqus, Ansys, Pam-Crash, Radioss and LS-DYNA in addition to a tight integration with NX Nastran.

Many powerful tools are available within NX to automate and increase the efficiency of the finite element analysis process. Wireframe, surface and solid geometry can all be used simultaneously in finite element model generation. Free meshing, mapped meshing and manual mesh generation techniques as well as automated tet-based meshing for 3D solid parts are all available in conjunction with unique surface abstraction and section meshing capabilities. Automated tools for checking the quality of elements, mesh smoothing and applying loads and boundary conditions are also included. The user interface can be tailored specifically to the targeted solver, making it easy for the user to understand the finite element model characteristics in the CAE solver language familiar to the user. Comprehensive material and physical property definition are included, making NX the core suite of tools for a full multi-CAD, multi-physics digital simulation environment.

Visual is all about productivity and the Lifecycle Simulation strategy is focused on solutions, technology that is easier to use and more applicable for all levels of user. For example, robust automation capabilities free up analysts to spend more time defining questions that need to be answered.

NX supports multi-CAD CAE modeling and visualization with automated model generation and meshing technologies and the ability to quickly define, share and re-use CAE best practices across the enterprise.

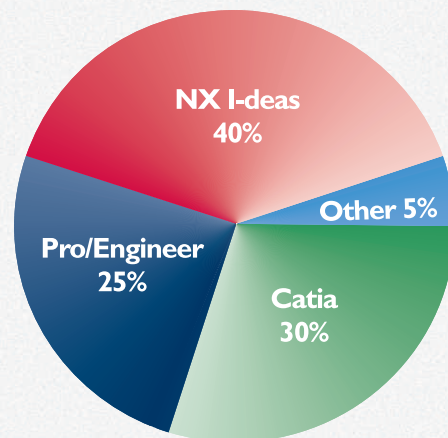

Multi-CAD profile of NX Simulation users

Visual knowledge

Siemens digital product development solutions enables companies to capture/ leverage the enterprise's collective knowledge into repeatable processes throughout the product development process.

Siemens offers the most complete range of knowledge-based engineering, design, manufacture and simulation tools, enabling you to:

- Streamline and automate entire engineering, design, simulation and manufacturing best practices and processes
- Automate validation to increase quality and efficiency
- Reduce variability and the main cause of errors
- Provide highest levels of product development efficiency – with orders of magnitude advantage over other approaches

Knowledge-enabled simulation

With NX knowledge-enabled capabilities, companies can create templates that can be instantly loaded and automatically executed as stored processes. As an example, a wheel manufacturer can capture its best practices for designing and analyzing various types of standard wheels and define that process in a template file. Users only need to drag the template onto the geometry and start the process. Process assistants can be developed by simulation experts to enable the same process to be executed accurately by new employees or by design engineers using a wizard-like tool. These same automation techniques enable preferred simulation processes to be followed for each type of workflow or product evaluation activity leading to higher staff productivity, higher product quality and consistency of engineering results. This effectively brings fundamental performance simulation activity into the upfront design process and supports enterprise-wide initiatives to capture in-house knowledge and proven repeatable simulation methods.

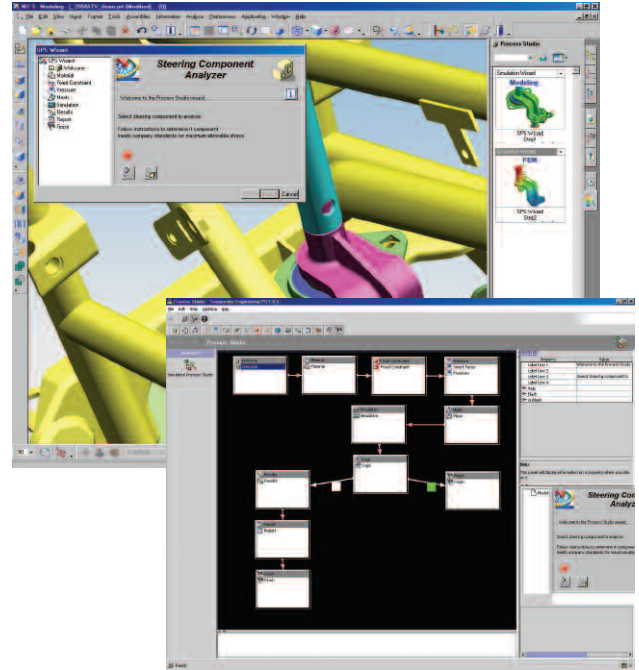

If VMStress < 45	replace chamfer(4) with blend (8)
If v4 < VMStress < 60	OK
If VMStress > 60	consult w/expert

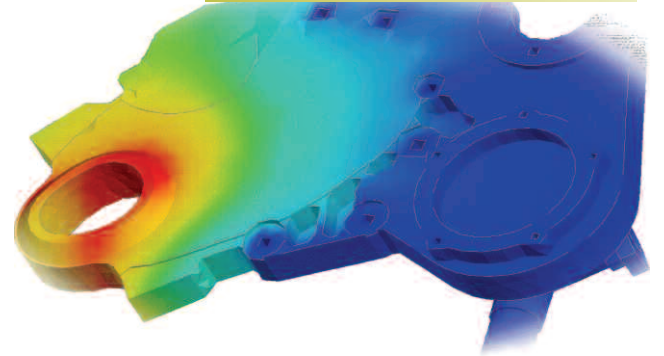

PROVEN VALUE

► *“Our goal is to use advanced analysis to significantly reduce dependencies on physical prototypes. This depends upon pervasive use of analysis throughout our product development organization. We are evaluating NX Simulation Process Studio for its ability to encapsulate specialist knowledge and best practices and deploy them in a way that is much more user-friendly and valuable to the design engineer.”*

*Fred Homma
General Manager
CAE and Systems Promotion Department
Isuzu*

Managed knowledge

Transforming the process

The complexity of a managed simulation environment cannot be underestimated. Starting with requirements that define performance, market and regulatory needs, engineers need an environment that helps them understand what if anything is available for re-use; an environment that connects their initial concept models to later detail design and test data; an environment that encourages knowledge capture and re-use – extending the value of simulation to constituencies in the organization. Siemens is unique in its ability to add value. No other company in the world combines the depth of understanding and market strength in data management with similar strengths in engineering simulation and the ability to implement a long-term vision.

Customer experience

The CAE element was especially crucial for the vehicle body design team. They have now evolved from a serial, post-design freeze CAE process based on multiple departments and manual data exchange across multiple CAD/CAE tools to a parallel, integrated body design and analysis process. The streamlined process is enabled by a common application platform and CAE master model, working in the context of a managed development environment.

Faced with increasing global competitive pressures, a major automotive OEM decided that the only way to design faster was to fundamentally change its design, engineering and manufacturing processes. To meet this challenge, the team identified a number of areas, including improving the group's use of simulation capabilities at all points throughout the product development process.

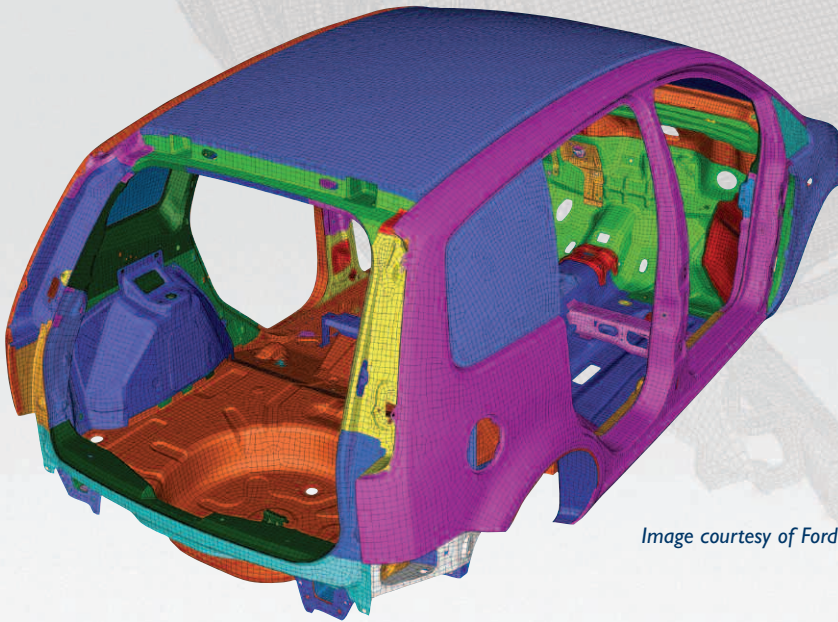

Image courtesy of Ford Motor Co.

PROVEN VALUE

► *“We have reduced our cycle time partly because we fixed disjointed processes – and partly because of the process changes driven by new IT tools. We are not constrained by a six-month or nine-month ROI target. We are looking at this from a holistic perspective – how do you design a car 50 percent more quickly. We know that companies that cannot do this will fade away. Private enterprises have to evolve at a fantastic rate to stay competitive.”*

*John Sullivan
Chief Engineer for Body Product Development
Ford Europe*

*Excerpt from “Digital Simulation to Meet Today’s Product Development Challenges”
Daratech, Inc. White Paper*

> **Real-time,
visual,
managed,
open**

A managed development environment for simulation

Siemens is unique. The advanced simulation and CAE technologies in NX are integrated with the entire NX product development and Teamcenter data management portfolios. Data management capabilities work “out of the box” and companies can implement a complete environment for managing CAE data, process and workflow as part of a wider product development environment. This reduces waste by promoting the re-use of existing designs and engineering knowledge. It synchronizes data and makes it readily accessible through data mining, visualization and reporting.

Advanced knowledge capture

A key strength of the NX environment is its capability to incrementally capture expert knowledge to automate simulation processes. Companies can harness knowledge with the NX Simulation Process Studio to standardize best practices and analysis procedures for use by less expert users. Companies can implement from the bottom up to help eliminate cultural barriers, reducing risks and increase effectiveness of the resulting simulation environment.

Processes implemented in NX Simulation Process Studio are self documenting, easy to modify and controlled within the corporate data management environment. Development teams can more effectively promote and implement process standards, supporting best practice implementations which are a key element of Design for Six Sigma and Lean Design initiatives.

Process integration

Integration is a key to both the efficiency and the effectiveness of a design environment. NX applications have been successfully integrated within multi-CAD product development environments. NX Simulation Process Studio demonstrates the value of advanced tools that can be built on a common product foundation that include knowledge-based engineering, system-based modeling, change management, configuration control, product requirements tools and other product lifecycle management capabilities. Niche CAE software suppliers cannot develop and deliver on the process integration vision.

PROVEN VALUE

► **“A common technology platform is critical to simulation and analysis becoming a mainstream activity within product development. Siemens is visibly extending its PLM open architecture in its simulation framework. This approach enables Siemens’ partners and customers to take full advantage of the same knowledge and best practice capabilities that Siemens leverages for its own applications. We see this as a win-win situation for Siemens and its extended value chain.”**

Don Brown
Chairman
Collaborative Product Development Associates, LLC

PROVEN VALUE

► **“Turning a concept into a profitable product is not an easy task. It requires coordinating the innovation efforts of many to meet a common goal.”**

NPDI Executive Perspective 2005

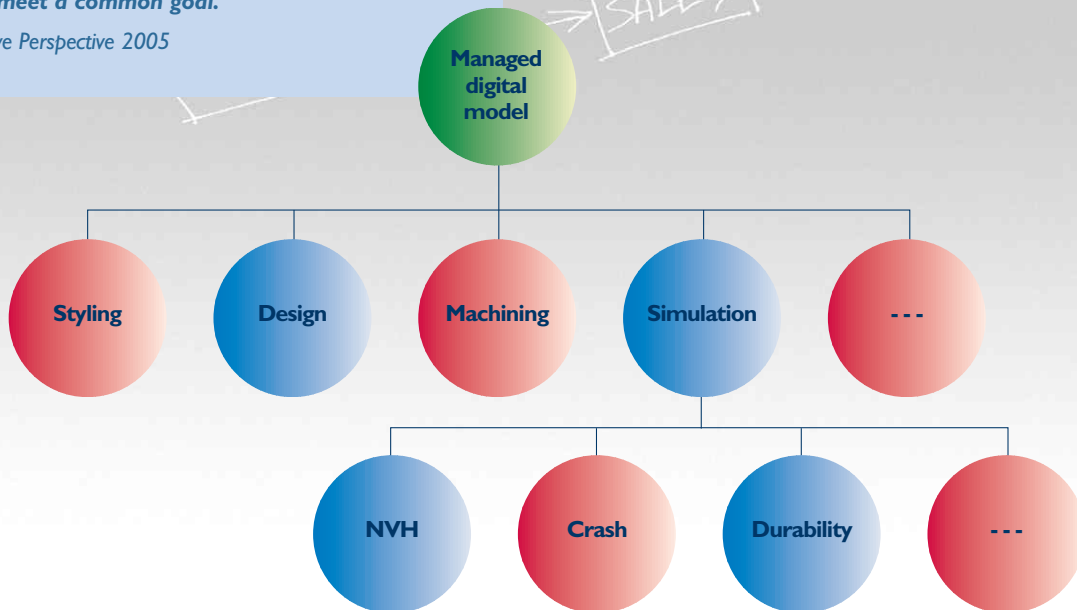

Simulation throughout the product lifecycle

Simulation and testing can no longer be viewed as a final validation activity. The true value of Lifecycle Simulation is not limited to program activities but comes in the continual downstream re-use of CAE data and the application of CAE domain knowledge to future

design programs. Simulation throughout the product development lifecycle requires the right tools integrated in a digital environment that constantly captures, updates and shares relevant engineering data and product knowledge to the entire global enterprise and supply chain.

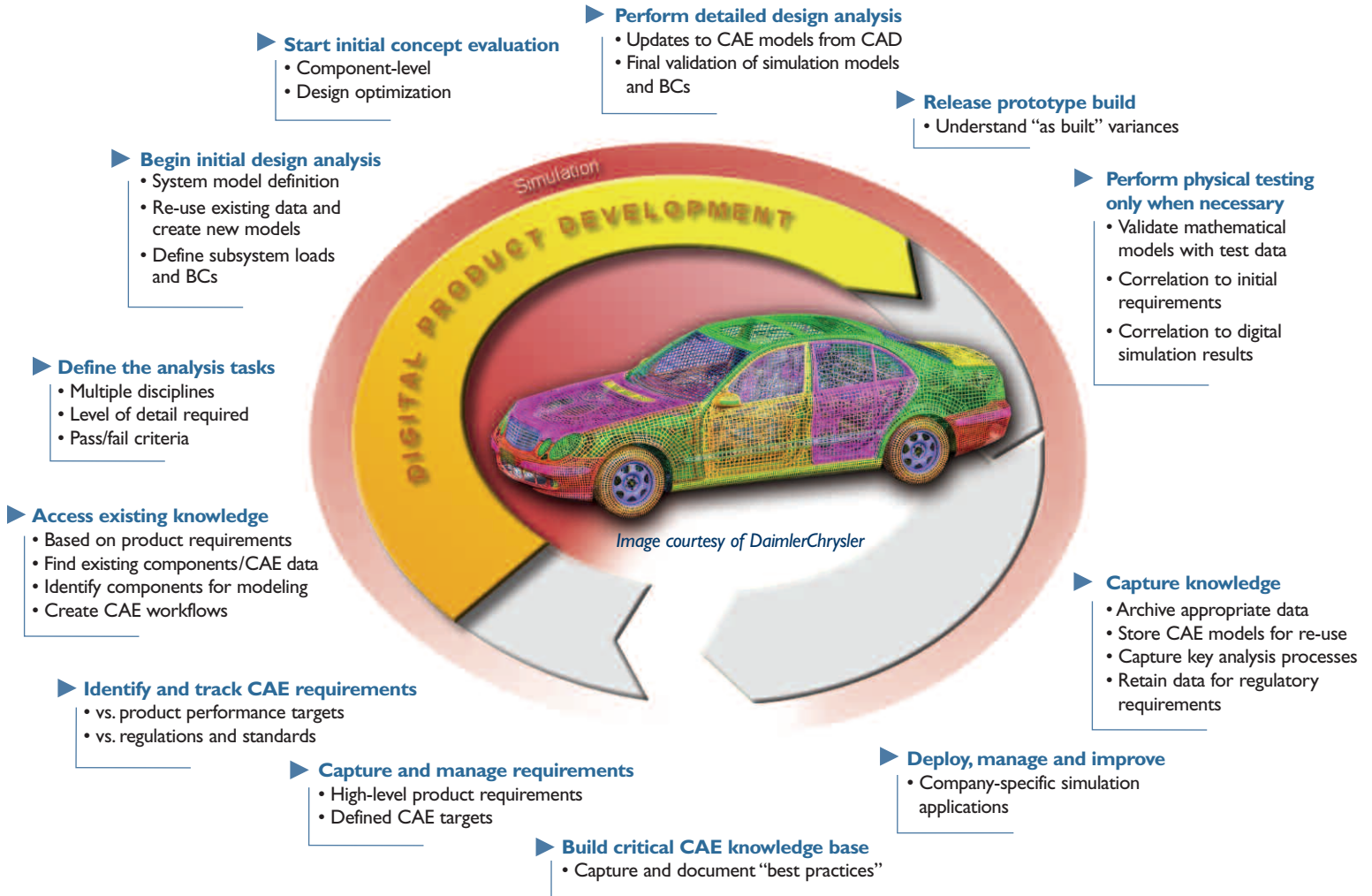

PROVEN VALUE

- ▶ **“It makes sense to start meshing components of the geometry before all the design details have been determined. This allows analysis to start as early as possible. But when we started meshing before the content was frozen, we needed to focus on how to manage the evolving data. If design changes are significant, we can start updating the mesh immediately...but only if we know about them.”**

Ulrich Fox
Supervisor, Body Methods Development Group
Ford Europe

Excerpt from “Digital Simulation to Meet Today’s Product Development Challenges”
Daratech, Inc.
White Paper
December 2003

Engineering analysis: a core strength of Siemens

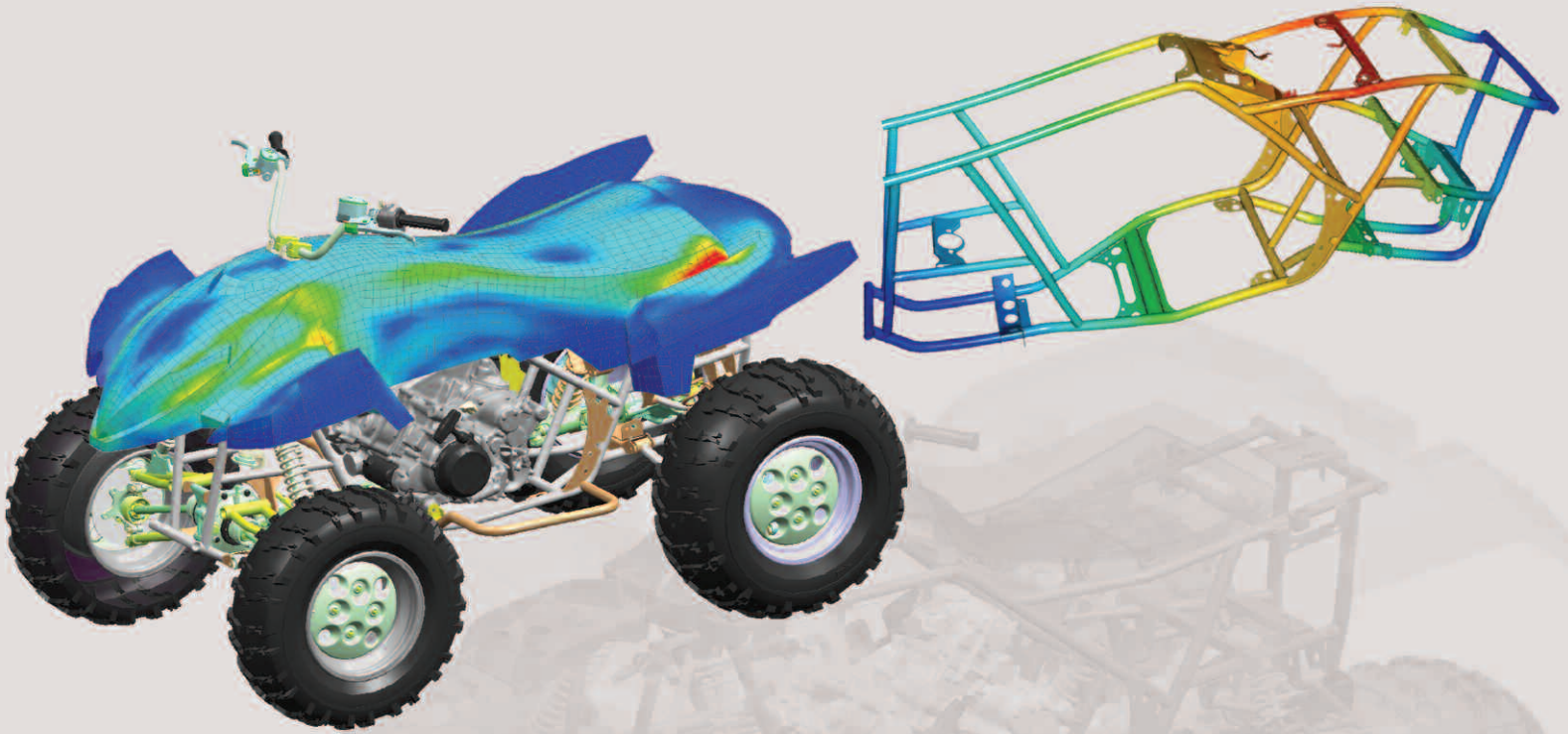

We understand your challenges

The right tools in the hands of the right people at the right time helps development teams expedite their work quickly and effectively. Analysts can deal with the most complex geometry using powerful de-features and updating technology. The implementation and automation of best practices with NX enables domain specialists to capture knowledge and best practices and safely enable broader use of simulation by more people. With pervasive use of validation tools at every step, companies can build quality and speed into the design process.

NX is an integral part of the unified product development environment. No other suite of product development solutions offers such a broad and powerful range of product and process coverage, completely integrated together. NX includes the widest and most flexible array of product modeling abilities, coupled with the most advanced simulation and manufacturing capabilities, integrated into a single product development environment.

Management of data and processes in the NX managed development environment adds to the efficiency and effectiveness of the whole team. It delivers the power to find and re-use existing analysis models and results. It automatically communicates design changes to avoid problems, errors and wasted effort. NX enables companies to start analysis at an earlier stage of design and provide real design impact.

- ▶ **An open system:** Founded on open standards and protocols, NX can be readily integrated with other product development tools and with business systems. This open system philosophy also enables better communication and collaboration in your supply chain.
- ▶ **Scalable:** From individuals to departments to globally networked development teams, from wizards to simple general-purpose design tools to full-featured, industrial-strength analyst capabilities, NX is packaged to meet the development needs of large or small organizations.

> **Adaptability,
flexibility,
scalability**



Lifecycle Simulation

Linear and nonlinear structural analysis

- Static and dynamic stress
- Normal modes
- Buckling
- Stress stiffening and spin softening
- Modal analysis with differential stiffness
- Dynamic response analysis
- Nonlinear material models
- Large displacement, large strain
- Material hardening and creep
- Node-to-node contact including friction
- 3D surface-to-surface contact
- Laminate composites analysis

Durability/fatigue analysis

- Strength and fatigue safety for cyclic loading (infinite life model)
- Advanced life and fatigue damage prediction (finite life model)
- Both uniaxial and biaxial stress cycles
- Utilize linear or nonlinear stress/strain results from FE models
- Utilize load time histories from physical test measurements

Thermal analysis

- Steady-state and transient response
- Conduction, convection and radiation
- Advanced radiation and environmental heating
- Coupled nonlinear analysis with 3D air flow, conduction, convection and radiation effects

Test/analysis correlation

- Validate mathematical models with physical prototype test results
- FE model updating – modal and FRF-based approaches

CAE data and process management

- Access high-level product performance requirements
- Define and share CAE targets based on design goals – system-level and components
- Capture key analysis processes across all disciplines
- Create CAE workflows for each project and discipline
- Archive and share important CAE knowledge and reports with virtual enterprise
- Store final CAE models in context of product BOM and associated CAD models for re-use throughout current product lifecycle as well as next generation products
- Retain required analysis results documentation for compliance with government regulatory and legal liability requirements

FE modeling/meshing

- Advanced geometry modeling and automated abstraction tools
- Wireframe, surface and solid geometry can coexist in same model
- Unique topology simplification tools
- Free meshing, mapped meshing, mesh smoothing and manual mesh generation
- Complete FE element library and physical property definition tools
- Advanced quad mesher for complex surfaces
- Robust, automated tet meshing for complex 3D solid parts
- Automated quality checking tools
- CAD-associative updates to CAE models
- Robust beam modeling
- Spot welding connections
- Seam welding connections enable joining of incompatible meshes
- Assembly-level FE modeling
- Assembly constraints on virtual parts
- FE-based as well as geometry-based loads and boundary conditions
- Cyclic symmetry
- Laminate composites modeling with multiple-ply material definitions
- Adaptable GUI for different FE solver environments/languages

Open interfaces

- Bi-directional translators to NX Nastran, MSC.Nastran, Ansys, Abaqus, LS-DYNA, Radioss, Pam-Crash, I-deas® ProTest software, PCB/ECAD
- CAD geometry – Catia, Pro/Engineer, SolidWorks, Solid Edge, Parasolid® software, ACIS
- Data exchange – IGES, STEP/VDA, STL, JT, MatLab, Excel, ADAMS MNF
- Over 30 third-party CAE solution partners provide direct interfaces to NX via PLM Components program

Materials

- Integrated materials libraries for common metals and U.S. Government handbook specs
- Elastic-plastic material models
- Gasket material models
- Hyper-elastic material model extensions – Ogden, Arruda-Boyce, foam
- Fluid material models (nonflow)

Motion

- Kinematics
- Multi-body dynamics
- Rigid and flexible bodies

Design optimization/variational analysis

- Geometry-based optimization
- FE-based optimization
- Design of experiments

> www.siemens.com/nx

Siemens Lifecycle Simulation

Siemens PLM Software is a single source for all your engineering desktop design simulation solutions as well as enterprise-level, multi-CAD advanced simulation solutions.

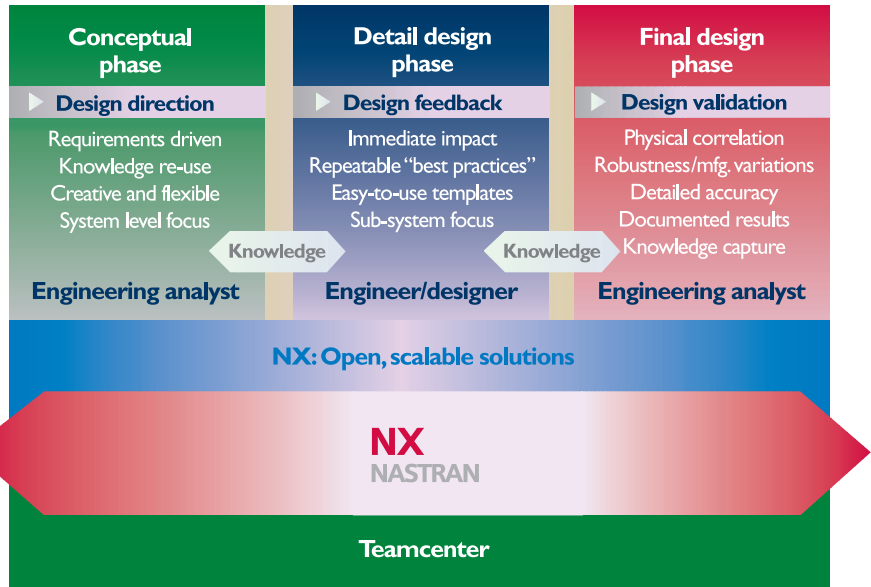

Process and data management applications

- ▶ **Teamcenter for simulation process management:** A CAE-specific Teamcenter module that enables the capture, re-use and sharing of CAE data, CAE product structure and CAE processes across the enterprise

Advanced simulation applications

- ▶ **NX Nastran:** Available standalone as an enterprise solution or seamlessly integrated at the core of many NX Simulation products. NX Nastran delivers comprehensive performance simulation capabilities for a broad range of engineering disciplines and industries. Siemens is dedicated to making NX Nastran the most complete and powerful solution available for functional digital prototyping and simulation.
- ▶ **NX Advanced Simulation:** An open, multi-CAD and CAE solver-neutral environment that enables rapid simulation as an integral part of the design process. Extensive geometry idealization and abstraction capabilities support rapid model simulation in a geometrically complex, multi-physics environment. Powered by an integrated NX Nastran desktop solver; users have direct access to comprehensive model review, structural optimization and results visualization capabilities to enable design decisions to be based on insight into real-world product performance.
- ▶ **NX Advanced FEM:** The power and functionality of NX Advanced Simulation for customers who wish to use an alternative solver (does not include NX Nastran).
- ▶ **NX Laminate Composites:** An add-on capability to NX Advanced Simulation that enables the evaluation of products made with laminate composite materials.
- ▶ **NX Response Simulation:** Provides an interactive, visual environment for the linear evaluation of the structural dynamic response of a system when subjected to complex loading conditions such as random vibration, transient, harmonic and shock spectra.

- ▶ **NX Flow and NX Advanced Flow Simulation:** A complete suite of CFD simulation capabilities available as add-ons in the NX Advanced Simulation environment.
- ▶ **NX Thermal and NX Advanced Thermal Simulation:** A complete suite of thermal simulation capabilities available as add-ons within the NX Advanced Simulation environment.
- ▶ **NX Electronic Systems Cooling Simulation:** An integrated solution that enables the evaluation of the cooling effects of airflow around enclosed, densely packed heat-generating electronics systems used in many industries.
- ▶ **NX Space Systems Thermal Simulation:** An integrated solution that enables the evaluation of complex heat transfer characteristics of space systems during both orbital and inter-planetary missions.
- ▶ **Customized Environments for Ansys, Abaqus and Nastran:** Add-ons to NX Advanced FEM that tailor the FE modeling and analysis process in language specific to the FE solver.

Design productivity applications

- ▶ **NX Design Simulation:** A design-integrated and easy-to-use NX application that enables design engineers to quickly evaluate the structural performance characteristics of 3D product design concepts earlier in the development process.
- ▶ **NX Motion Simulation:** A design-integrated environment for evaluating the kinematic and dynamic performance of new product designs.
- ▶ **NX Simulation Process Studio:** A portfolio of capabilities that enables in-house CAE experts to rapidly develop best practices wizards for enterprise-wide usage minimizing the need to rely on external consultancy services.

The NX advantage



Throughout its broad product application suite, NX leverages key attributes that help companies achieve business objectives of waste reduction, quality improvement, shorter cycle times and greater product innovation. These unique attributes directly support business process initiatives aimed at transforming product development:

- ▶ **Managed development environment**
NX solutions include fully integrated, synchronized management of all product data and process knowledge to transform product development with a structured collaborative environment.
- ▶ **Unified product development solution**
Seamless integration of NX applications rapidly propagates changes of product and process information, replacing point solutions with a unified development system, from concept to manufacturing.
- ▶ **Knowledge-driven automation**
With NX, companies can apply product and process knowledge across all elements of product development to automate processes and maximize re-use.
- ▶ **Simulation, validation and optimization**
Comprehensive simulation and validation tools in NX automatically check performance and manufacturability at every step of the development process for closed-loop, continuous, repeatable validation.
- ▶ **System-level engineering**
NX structured conceptual models standardize design practices and allow rapid creation of variants, transforming development from component-based design to a systems engineering approach.

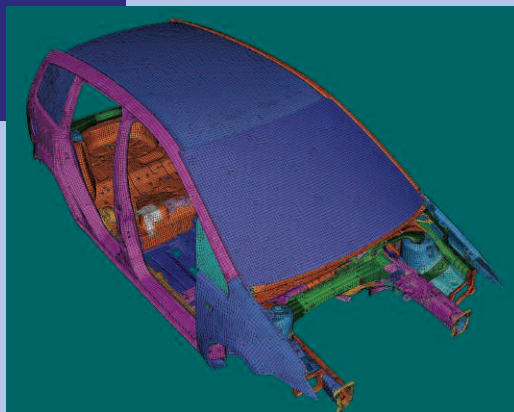
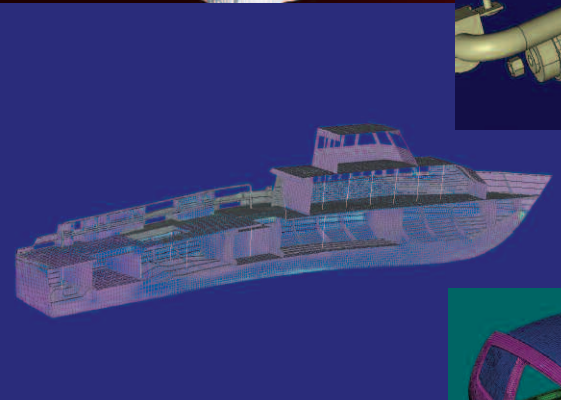
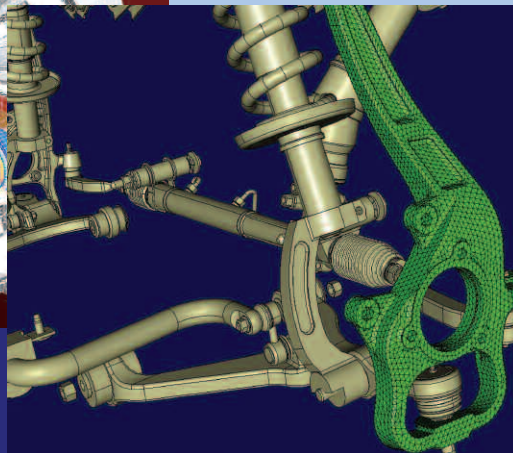
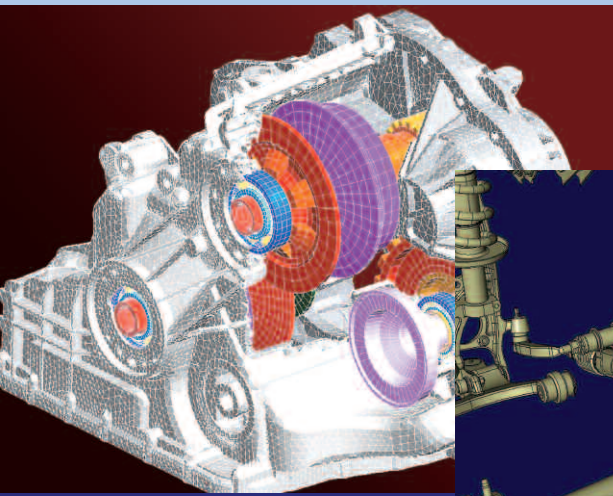

About Siemens PLM Software

Siemens PLM Software, a business unit of the Siemens Industry Automation Division, is a leading global provider of product lifecycle management (PLM) software and services with nearly six million licensed seats and 56,000 customers worldwide. Headquartered in Plano, Texas, Siemens PLM Software works collaboratively with companies to deliver open solutions that help them turn more ideas into successful products. For more information on Siemens PLM Software products and services, visit www.siemens.com/plm.

Siemens PLM Software

Headquarters

Granite Park One
5800 Granite Parkway
Suite 600
Plano, TX 75024
USA
972 987 3000
Fax 972 987 3398

Americas

Granite Park One
5800 Granite Parkway
Suite 600
Plano, TX 75024
USA
800 498 5351
Fax 972 987 3398

Europe

3 Knoll Road
Camberley
Surrey GU15 3SY
United Kingdom
44 (0) 1276 702000
Fax 44 (0) 1276 702130

Asia-Pacific

Suites 6804-8, 68/F
Central Plaza
18 Harbour Road
WanChai
Hong Kong
852 2230 3333
Fax 852 2230 3210

www.siemens.com/plm

© 2009 Siemens Product Lifecycle Management Software Inc. All rights reserved. Siemens and the Siemens logo are registered trademarks of Siemens AG. Teamcenter, NX, Solid Edge, Tecnomatix, Parasolid, Femap, I-deas and Velocity Series are trademarks or registered trademarks of Siemens Product Lifecycle Management Software Inc. or its subsidiaries in the United States and in other countries. All other logos, trademarks, registered trademarks or service marks used herein are the property of their respective holders.

1103-W 7 8/09