

LS-TaSC™ Product Status

Willem Roux¹, Imtiaz Gandikota¹, Katharina Witowski², Peter Schumacher²

¹Livermore Software Technology Corporation
²DYNAMore GmbH

1 Introduction

The LS-TaSC Version 3.1 topology and shape design tool is presented, as well as the major new features in LS-TaSC Version 3.0. The presentation introduces the multi-point numerical derivatives scheme that allows constrained optimization using the mass fractions and load case weights as variables. This allows constrained optimization using any response or mathematical expressions as constraints or objectives. Additionally, the post-processing of the final design geometry by the creation of iso-surfaces is also reviewed. Application examples illustrate these capabilities.

2 Major new Feature in LS-TaSC Version 3.0

2.1 Free Surface Design

The surface of a solid part can be redesigned to reduce stress concentrations. A design surface is defined using a `*SET_SEGMENT` definition in the LS-DYNA input deck. Geometry and manufacturing definitions may be specified: symmetry and extrusion constraints and a smooth transition between the free surface and the surrounding material are available. The objective is to have a constant stress over the design surface.

2.2 Integration in LS-PrePost

Since LS-TaSC Version 3.0 the graphical user interface is integrated into the LS-PrePost framework, Fig. 1. Picking of parts and surfaces is possible, as well as integrated editing of the LS-DYNA model e.g. to create entities required for the LS-TaSC design. Post-processing is also integrated from Version 3.1.

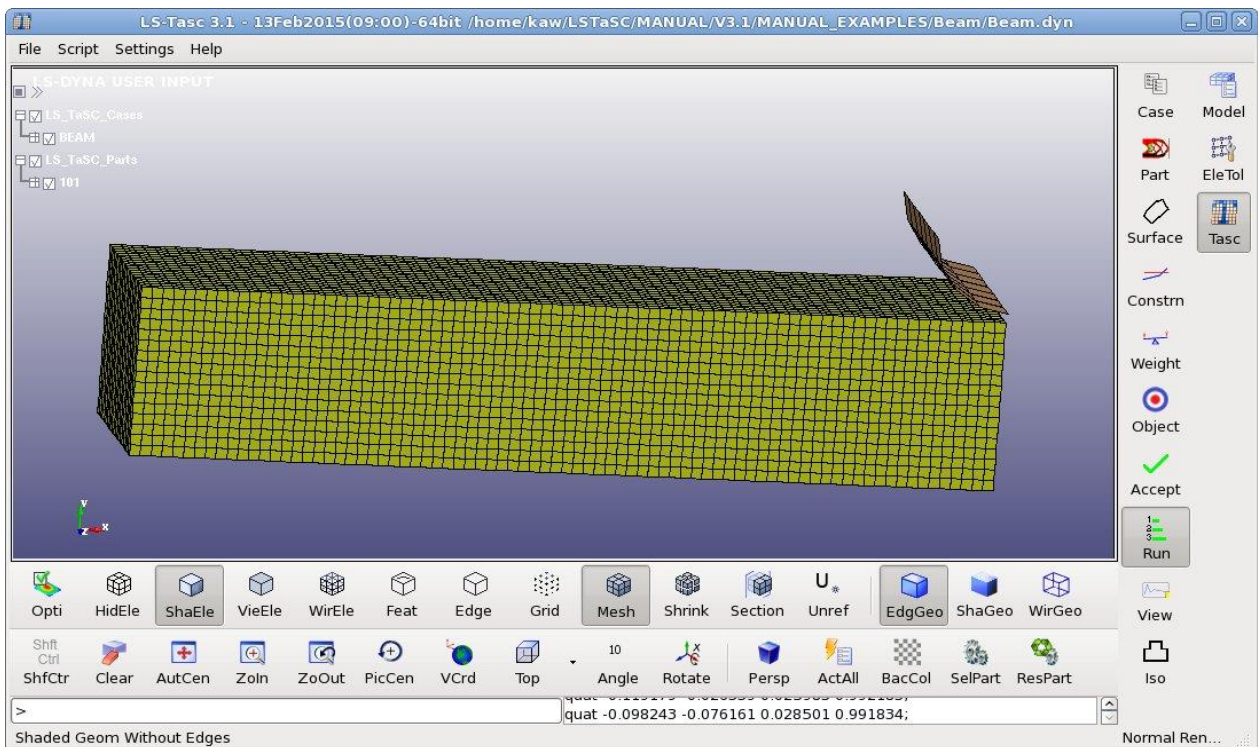

Fig. 1: LS-TaSC GU integration into the LS-Prepost framework

3 Multi-point Optimization

Multi-point optimization is used to solve constrained optimization problems. Two sets of variables are used in a simultaneous iterative process. The global variables, such as the part mass fraction and the load case weights, are used to satisfy the constraints, while the element density variables are used to simultaneously compute the load paths. The two sets of variables are treated differently in the design algorithm: the local variables are computed using a suitable method such as fully stressed design, while the values of the global variables satisfying the constraints are computed using numerical derivatives and mathematical programming. This methodology has the advantage of allowing more general constraints, Fig. 2.

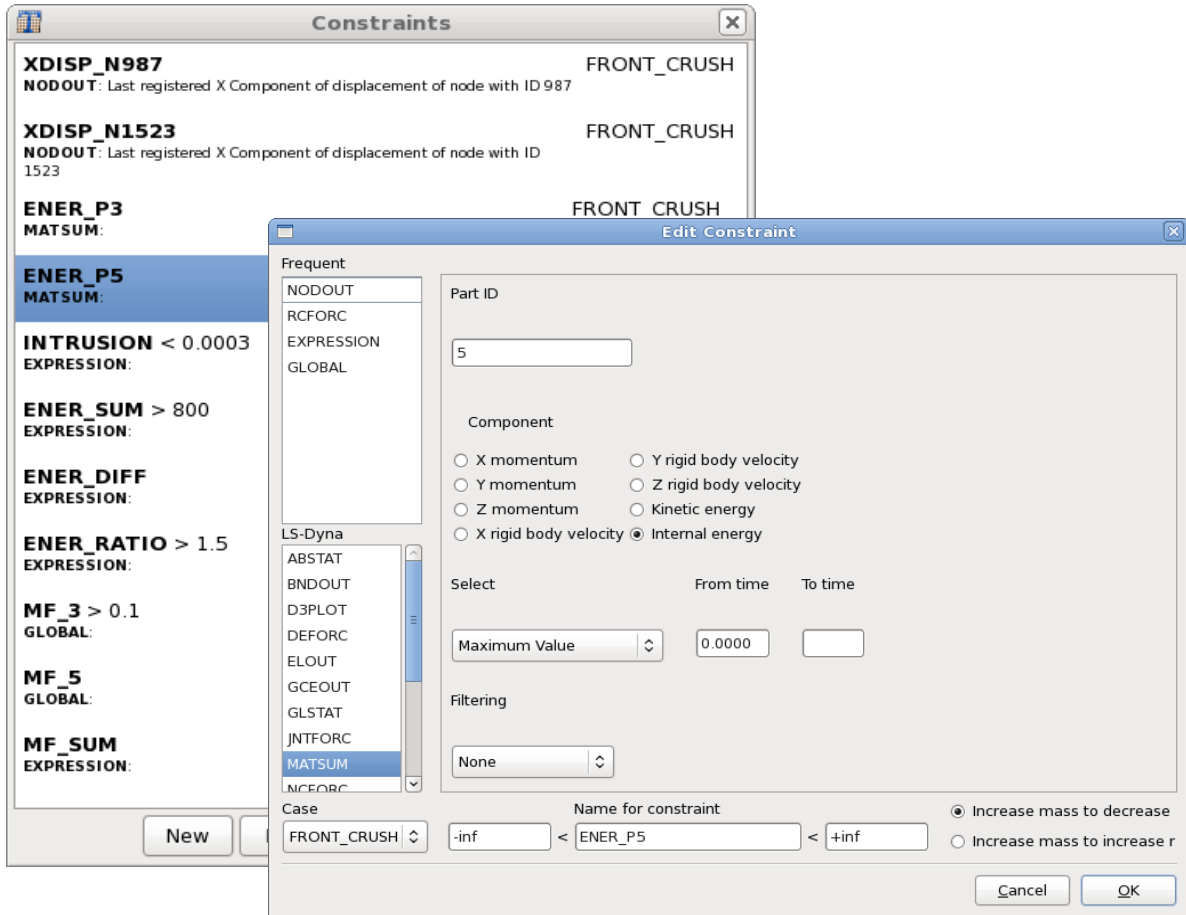

Fig.2: Definition of constraints: Interfaces to LS-DYNA output results, expressions, global constraints

4 Iso-surfaces

For solid element designs, a surface containing the final optimal structure can be created and stored in the LS-DYNA input format, Fig. 9. All elements with a variable value larger than a selected value are included.

5 Examples

5.1 Free Surface Design

The component and the load case considered in this example are displayed in Fig. 3. The brown surfaces are selected for redesign. The initial and final designs are displayed in Fig. 4 with the effective stress fringed on the model. A stress reduction of 20% could be achieved.

The results obtained with and without edge smoothing are displayed in Fig. 5.

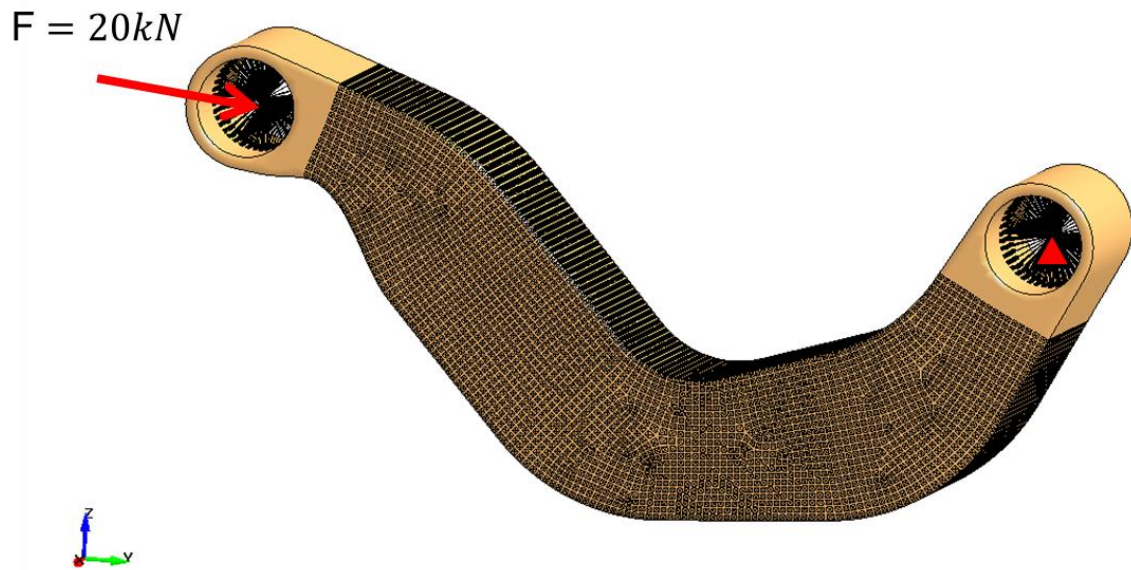

Fig.3: Free Surface Design: Initial model and load case

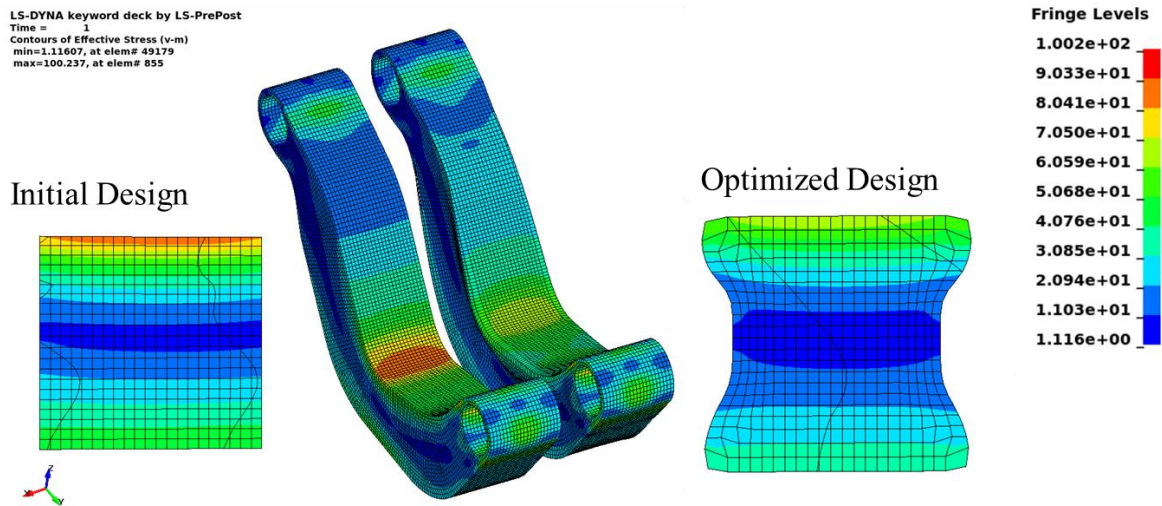

Fig.4: Free Surface Design: Initial model and final design; fringe component effective stress; a stress reduction of 20% could be achieved.

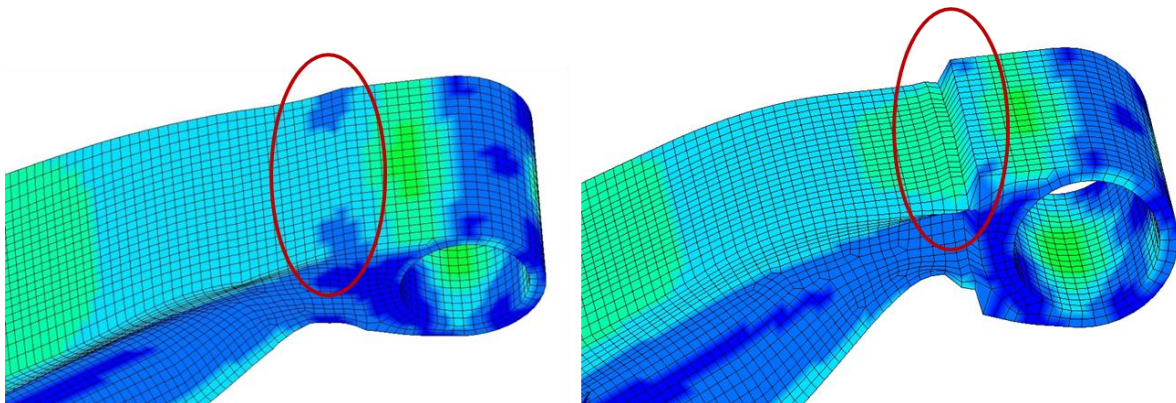

Fig.5: Free Surface Design: Result with (left) and without (right) edge smoothing.

5.2 Topology Optimization of a Bottle Opener

A bottle opener was optimized considering the two load cases depicted in Fig. 7. The desired mass fraction was 0.4 and an extrusion constraint was defined.

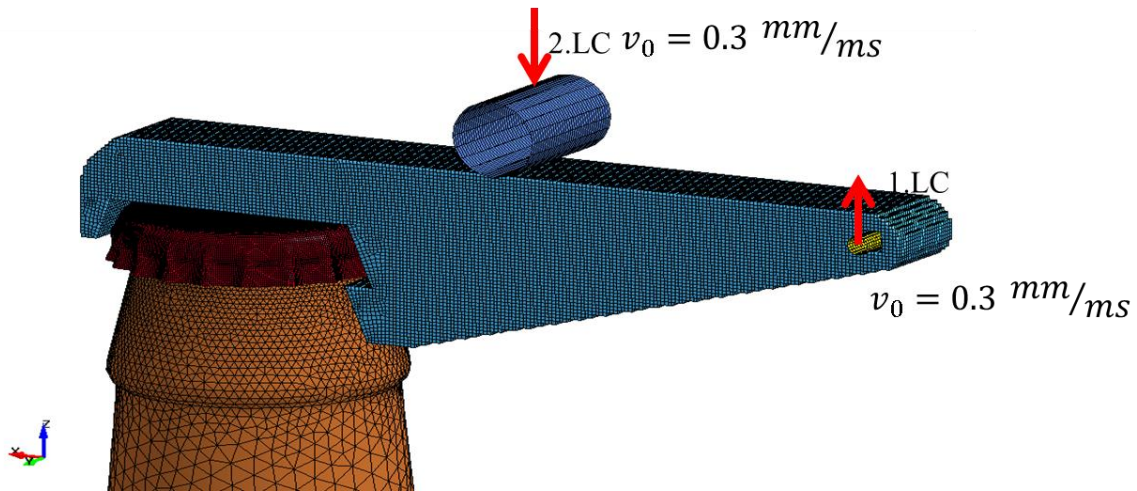

Fig.6: Example Bottle Opener: Load cases and initial design.

The results are displayed in Fig. 7 to Fig. 9. Fig. 7 displays the evolution of the topology from the initial design to the final design. The fringe component is the density distribution. Fig. 8 shows the optimal topology colored by the 1st principal stress, and an iso-surface containing the final structure is displayed in Fig. 9.

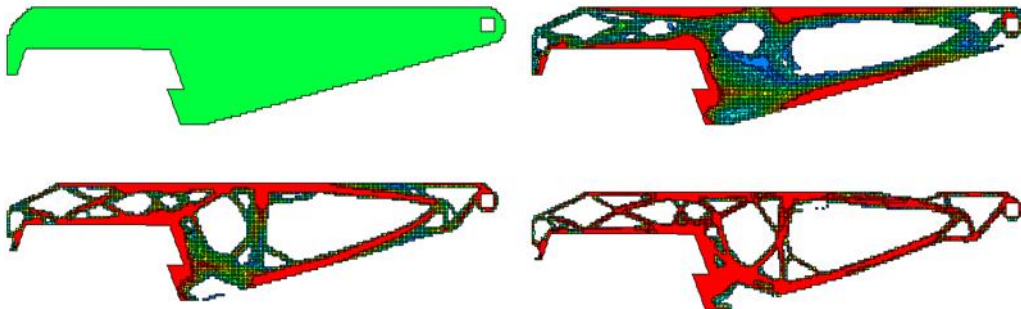

Fig.7: Example Bottle Opener: From initial design to optimum, fringe component density distribution.

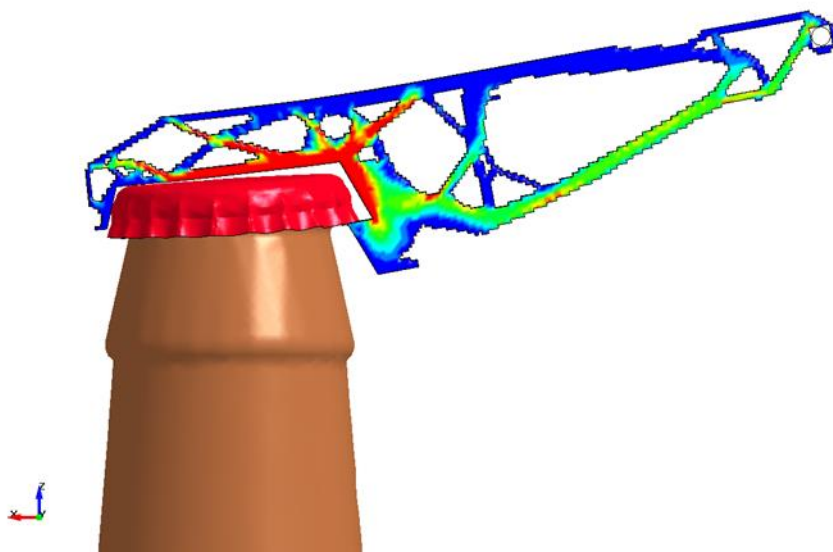

Fig.8: Example Bottle Opener: Final design; fringe component 1st principal stress.

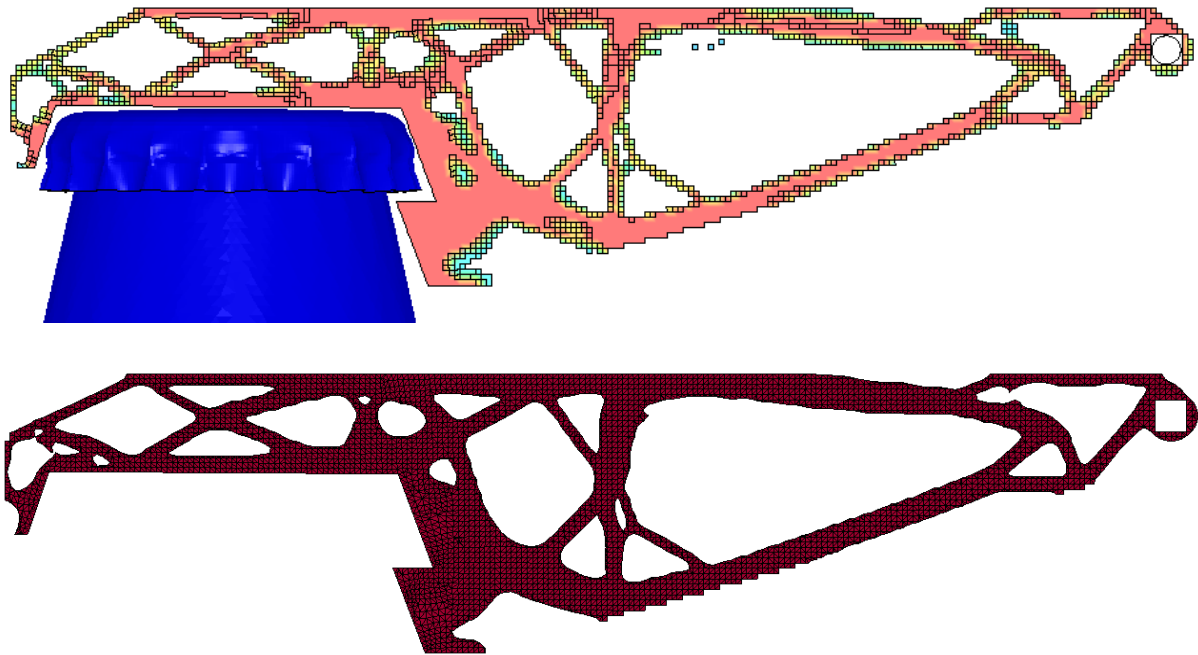

Fig.9: Example Bottle Opener: Final Design (top) and Iso-Surface (bottom)

5.3 Bonnet Case Study (Courtesy of JLR)

The bonnet to be optimized is displayed in Fig. 10. The bonnet is discretized using solid elements with a layer of shell elements on top. The solid part is the design part. Three load cases are considered here, latch bend, rear beam and torsion. All load cases are nonlinear including contact, and a displacement constraint was defined for each load case. The multi-point method was used to solve the optimization problem. The desired mass fraction was 1%, and a maximum of 30 iterations was allowed.

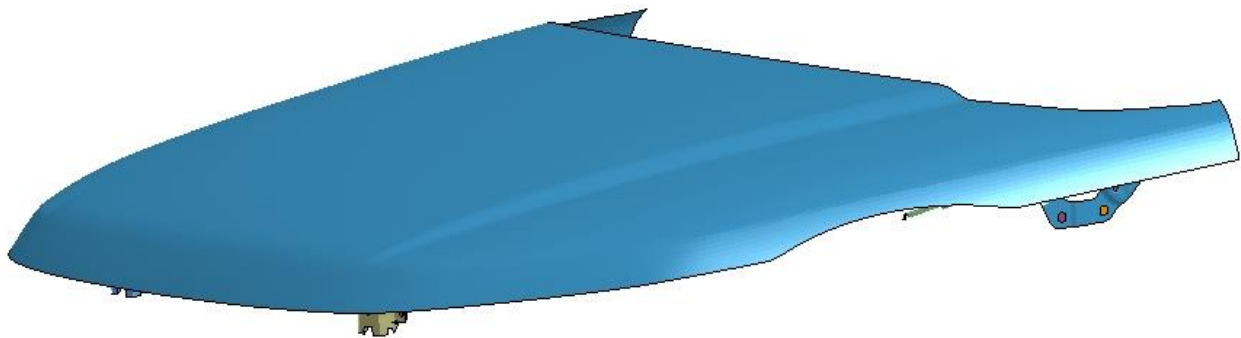

Fig.10: Bonnet: original design

The topology histories for the load case weights, the constraints and the mass fraction are displayed in Fig. 11 and Fig. 12. All constraints are satisfied for the final design with a mass fraction of 4.5%. The initial and final designs are shown in Fig. 13.

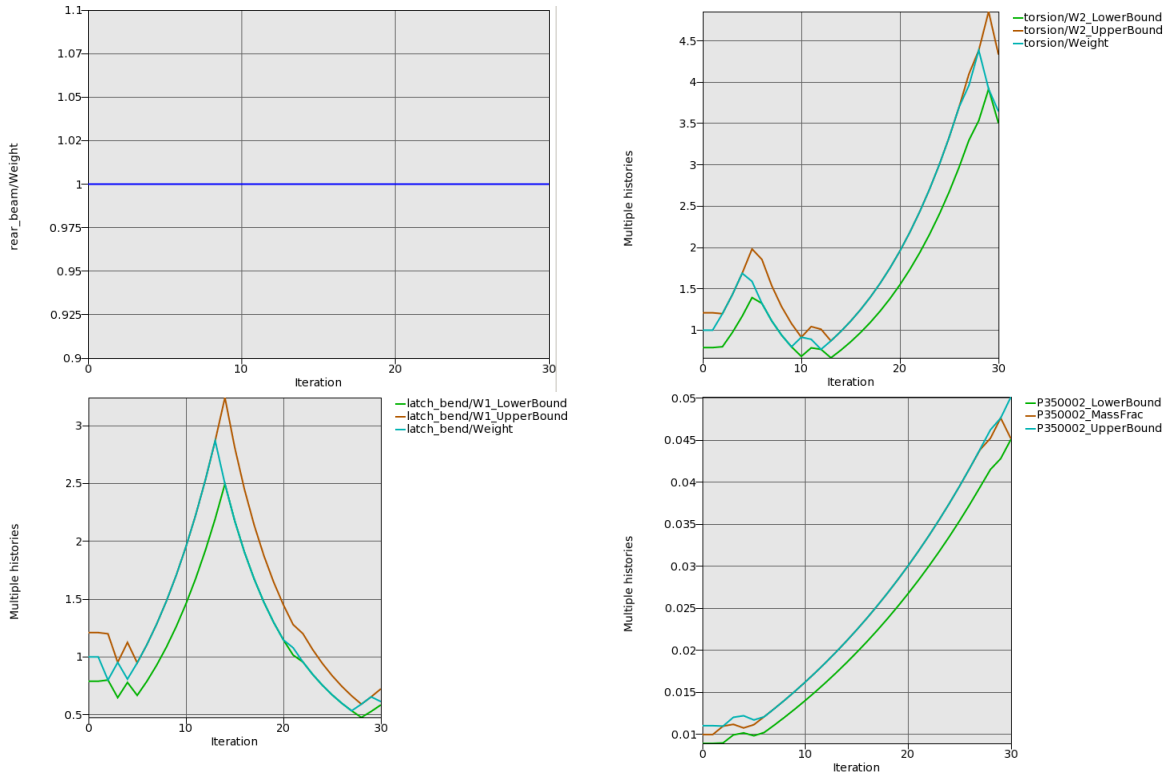

Fig.11: Bonnet Case Study: Topology histories for load case weights and mass fraction.

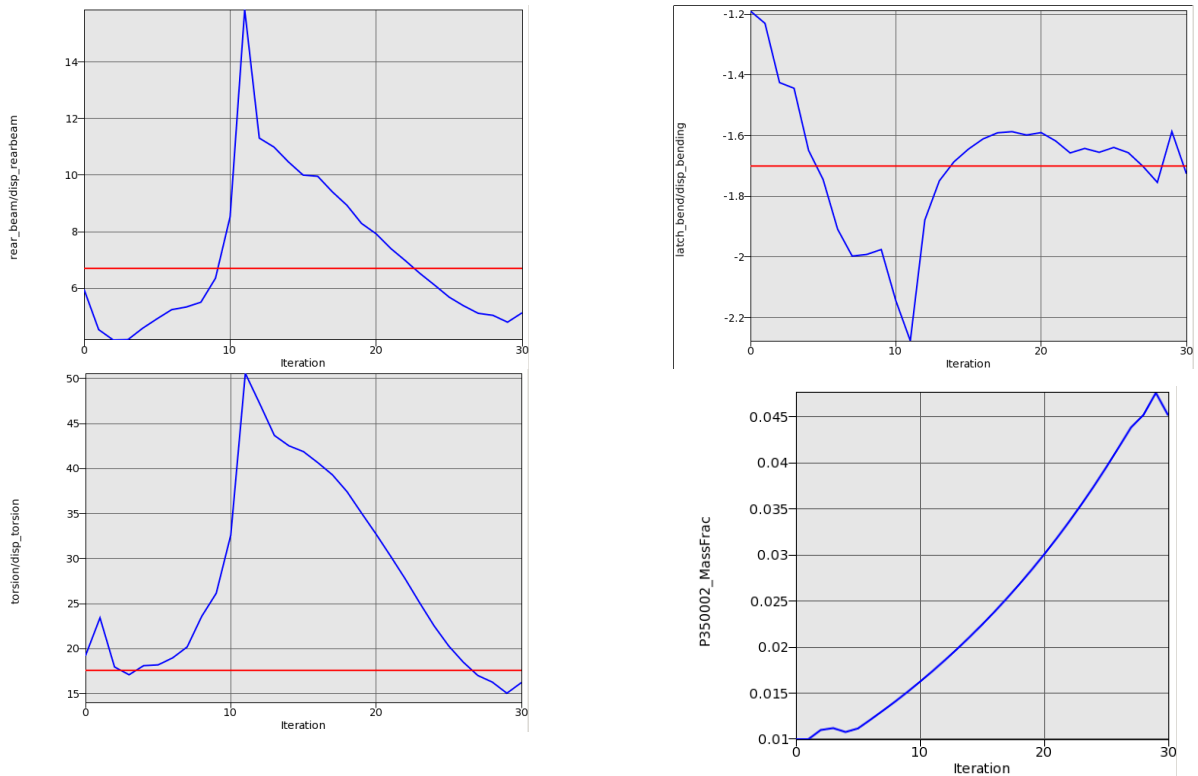

Fig.12: Bonnet Case Study: Topology histories for constraints and mass fraction.

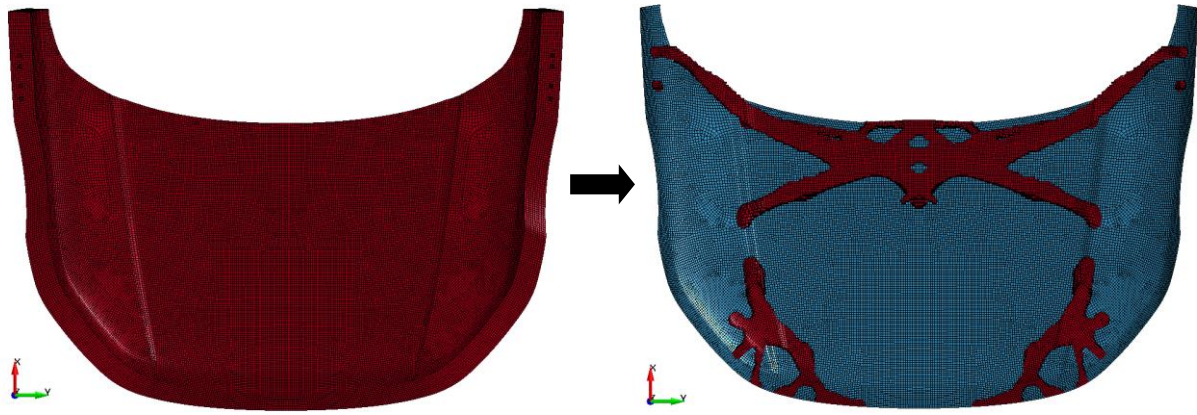

Fig.13: Bonnet Case Study: Initial design (left) and final structure (right)

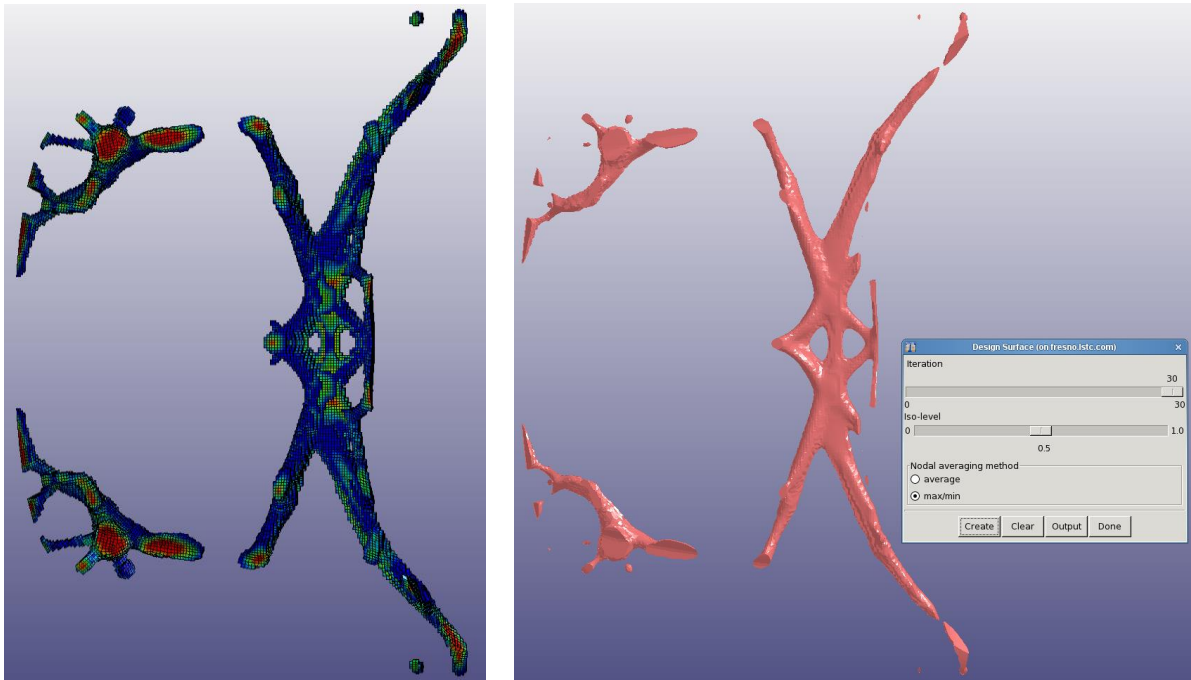

Fig.14: Bonnet Case Study: Final structure (left) and iso-surface (right))

6 Summary

The major new features of LS-TaSC Version 3.0 and 3.1 were presented.

Free surface design was introduced in Version 3.0. The surface of a solid part can be redesigned to reduce stress concentrations. In Version 3.1, constrained optimization was implemented, which allows more general constraints.

In Version 3.0 the LS-TaSC GUI was integrated in the LS-PrePost framework for more convenient setup of the optimization and preparation of the model. In Version 3.1, post-processing is also integrated, and iso.-surfaces containing the final optimal structure can be generated.

7 Literature

- [1] Roux, W.: "LS-TaSC™ Tool Topology and Shape Computations User's Manual", Version 3.1, Livermore Software Technology Corporation, Livermore 2015