

Updates to LSTC's LS-DYNA[®] Anthropomorphic Models

Christoph Maurath, Sarba Guha
Livermore Software Technology Corporation

Abstract

This paper shows the progress of LSTC's LS-DYNA crash test dummy model development effort. It is an update to the presentation and paper "Overview of LSTC's LS-DYNA[®] Anthropomorphic Models", presented at the 11th International LS-DYNA Users Conference. Updates and details of all released models are presented. The development status of models currently under development is addressed. Outlook to future models is given.

Introduction

LSTC's LS-DYNA anthropomorphic models have gone through many changes and updates in recent years. Further, several models were added and are currently being developed.

For an overview of the development process, please refer to "Overview of LSTC's LS-DYNA[®] Anthropomorphic Models", presented at the 11th International LS-DYNA Users Conference [1].

In the first section of this paper all released dummy models are shown and described.

In the second section the status of models currently in development is given.

The third section describes planned models and a general outlook on LSTC's dummy model development.

All of LSTC's publicly released models are distributed free of charge to licensees of LSTC's LS-DYNA software who are current with their annual license fees (Annual License) or maintenance fees (Paid-up License) [2].

Released Anthropomorphic Models

All of LSTC's released models can be obtained through LSTC's ftp site, LSTC's website, or LS-DYNA distributors. For further details about individual models, please refer to the documentation included in a package with the keyword file of the models or to the header of the keyword file of the model [2].

Hybrid III Rigid-FE and Hybrid III FAST adult models

These models include a 5th percentile female, a 50th percentile male, and a 95th percentile male version of the Hybrid III dummies. They are based on simple models that were originally developed in the mid 1990s. In the last several years the models' run stability and response performance were significantly improved and customer feedback was incorporated. Since the last release the models have been further improved based on comparisons to data from physical sled tests. Improved versions of the 50th percentile and the 5th percentile have been released as FAST models. The name change from Rigid-FE to FAST was implemented to avoid confusion.

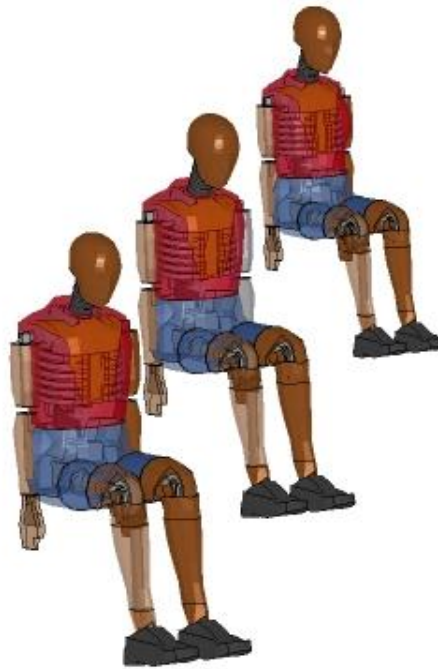

Figure 1: Hybrid III Rigid-FE adult models

Hybrid III 50th percentile male

The detailed model of the Hybrid III 50th percentile male dummy is a joint development with the National Crash Analysis Center (NCAC) at The George Washington University in Washington, D.C.

An initial ALPHA model was released in summer of 2009. Since then the correlation to test data from calibration tests and also performance tests has been significantly improved, based on detailed customer feedback. The latest BETA version was released in February of 2012.



Figure 2: Detailed Hybrid III 50th percentile male

Hybrid III 5th percentile female

The detailed model of the detailed Hybrid III 5th percentile female dummy is a joint development with NCAC.

The current version was released in January of 2011.



Figure 3: Detailed Hybrid III 5th percentile female

Hybrid III 95th percentile male

The detailed model of the 95th percentile male Hybrid III dummy is a joint development with NCAC.

The current version, which was released in February of 2012, is scaled up from the detailed Hybrid III 50th percentile. The mass distribution was adjusted to accurately represent the 95th percentile dummy.



Figure 4: Detailed Hybrid III 95th percentile male

Hybrid III Rigid-FE 50th male standing

This model is a standing version of the Hybrid III 50th percentile male dummy. Based on the original sitting 50th percentile Hybrid III, the spine, pelvic bone, pelvic flesh, and upper leg flesh have been modified for this model. The initial version has been release and currently we are searching for calibration data and await customer feedback.



Figure 5: Hybrid III Rigid-FE 50th male standing

USSID

The model of the USSID is based on a publicly available model from the National Highway Traffic Safety Administration (NHTSA). Its jacket, arm and pelvic foam discretization have been improved. The material data for the foam parts was also improved. A single global contact was implemented and a positioning tree for LS-PrePost[®] was added. The latest update was the addition of a head accelerometer into the model.



Figure 6: USSID

SID-IIs D FAST

The reduced model of the SID-IIs is based on our detailed model (see below). Most parts are significantly simplified to achieve faster runtimes compared to the detailed version. The model was released in September 2011.

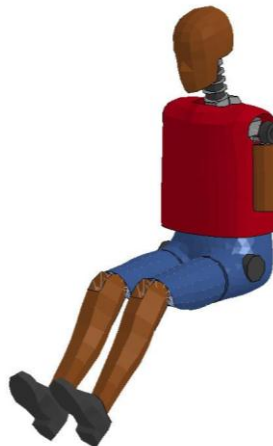

Figure 7: SID-IIs D FAST

SID-IIs D

The detailed model of the SID-IIs revision D was initially released in 2008. Since then customer feedback has been incorporated and the model was rereleased in 2009. Currently customer feedback and additional test data are being utilized to improve the model.

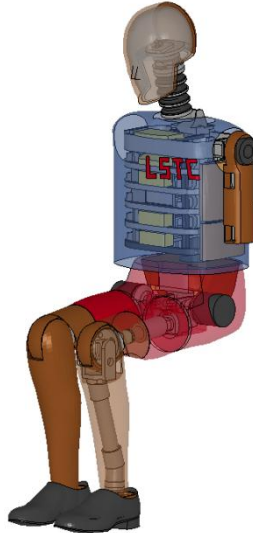

Figure 8: Detailed SID-IIs revision D

EuroSID-2re/EuroSID-2

The EuroSID 2re and EuroSID 2 dummy models are jointly developed with DYNAmore GmbH in Germany.

Both are detailed models and were released in 2009. Updates to both models were released in early 2010. We are currently working on updates based on customer feedback and additional test data.

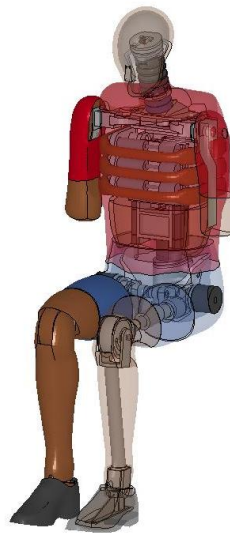

Figure 9: Detailed EuroSID-2re

Free Motion Headform

The latest released version of the Free Motion Headform includes a different way of head skin to skull interaction compared to earlier versions. Further, the material representing the head skin now incorporates data from physical material tests. The latest version was released in 2010.

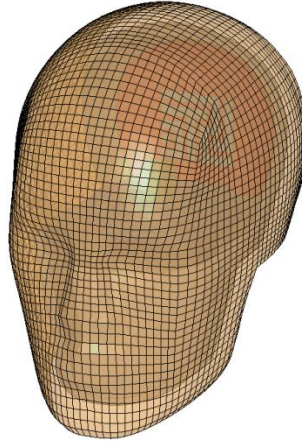

Figure 10: Free Motion Headform

Pedestrian Legforms

The Pedestrian Legform Impactor models were originally developed in 2001 based on EEVC WG 17 recommendations. Recently, both the Upper Leg Impactor and the Legform Impactor have been updated and revalidated according to European regulation 631/2009. Several small model corrections and improvements have been made. The latest version of the pedestrian legforms was released in August of 2010.

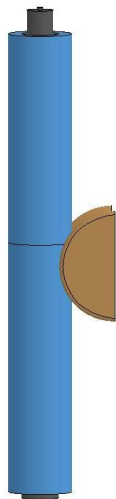

Figure 11: Pedestrian Legform Impactor

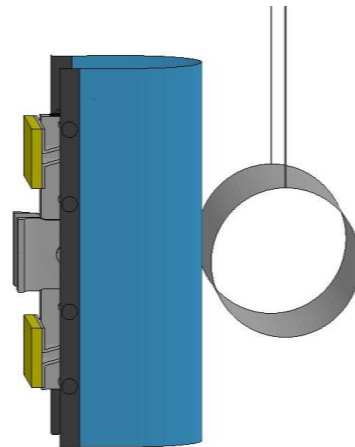

Figure 12: Pedestrian Upper Leg Impactor

Hybrid III six-year-old

The detailed model of the Hybrid III six-year-old dummy is a joint development with NCAC.

The initial version of the Hybrid III six-year-old was released in November of 2011. The latest version was released in April of 2012 and includes customer feedback.



Figure 13: Hybrid III six-year-old

BioRID II

An early ALPHA evaluation version of the BioRID II model was released in January of 2012. We are currently working on significant improvements and updates to the model together with customers.

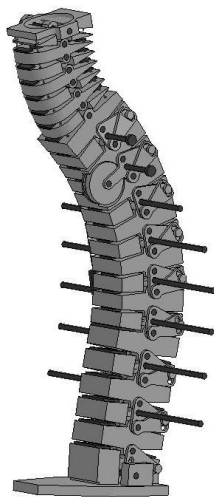

Figure 14: BioRID II spine



Figure 15: BioRID II Evaluation Version

Models in Development

The following dummy models are in various stages of their development.

Hybrid III three-year-old

The detailed model of the Hybrid III three-year-old dummy is in the calibration phase.



Figure 16: Hybrid III three-year-old

Ejection Mitigation Headform

The detailed model of the Ejection Mitigation Headform is in the calibration phase.

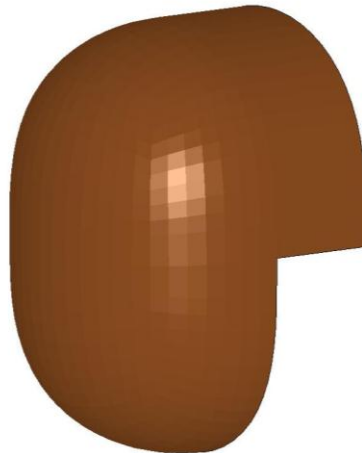

Figure 17: Ejection Mitigation Headform

WorldSID 50th percentile

The mesh of the WorldSID 50th percentile model is complete, except for the jacket. Currently the model is being built up.



Figure 18: WorldSID 50th, Half Arm

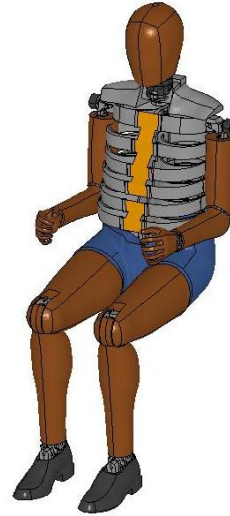

Figure 19: WorldSID 50th, Full Arm

Thor NT

The mesh of the Thor NT model is almost complete. Currently only the pelvis and jacket are missing.

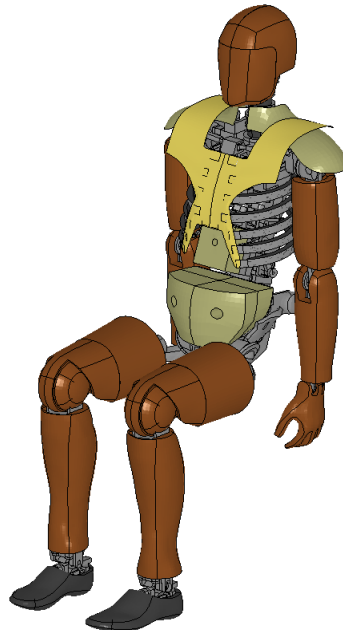

Figure 20: Thor NT

Hybrid II

At time of submission of this paper the meshing of the Hybrid II was just started. No image is available at this time.

Planned models and Outlook

We are planning to create models of most available dummies depending on customer request and feedback. Customers interested in aiding with the development or improvement of any dummy model, please contact us at atds@lstc.com.

Currently the following models are planned:

- Flex-PLI
- Q-series Child Dummies
- P-series Child Dummies
- FAST versions of EuroSID 2 and EuroSID 2re

Details about individual models, their development process and certification test results can be found in the documentation accompanying the models.

We endeavor to make the models as complete, accurate, reliable, and easy to use as possible. Suggestions and comments should be e-mailed to atds@lstc.com. Please report any errors encountered in either the documentation or results immediately to LSTC through your site focus.

References

- [1] Maurath, C., Guha, S., et. al., “Overview of LSTC’s LS-DYNA[®] Anthropomorphic Models”, 11th International LS-DYNA Users Conference, Dearborn, MI, 2010
- [2] <http://ftp.lstc.com/user/> , LSTC’s ftp site
- [3] <http://ecfr.gpoaccess.gov/> , Electronic Code of Federal Regulations, Title 49, Part 572
- [4] <http://eur-lex.europa.eu/> , European pedestrian safety regulation
- [5] www.truegrid.com, **TrueGrid**[®] is a Registered Trademark of [XYZ Scientific Applications, Inc.](http://www.truegrid.com)

